

CITY OF WINNIPEG Water and Waste Department

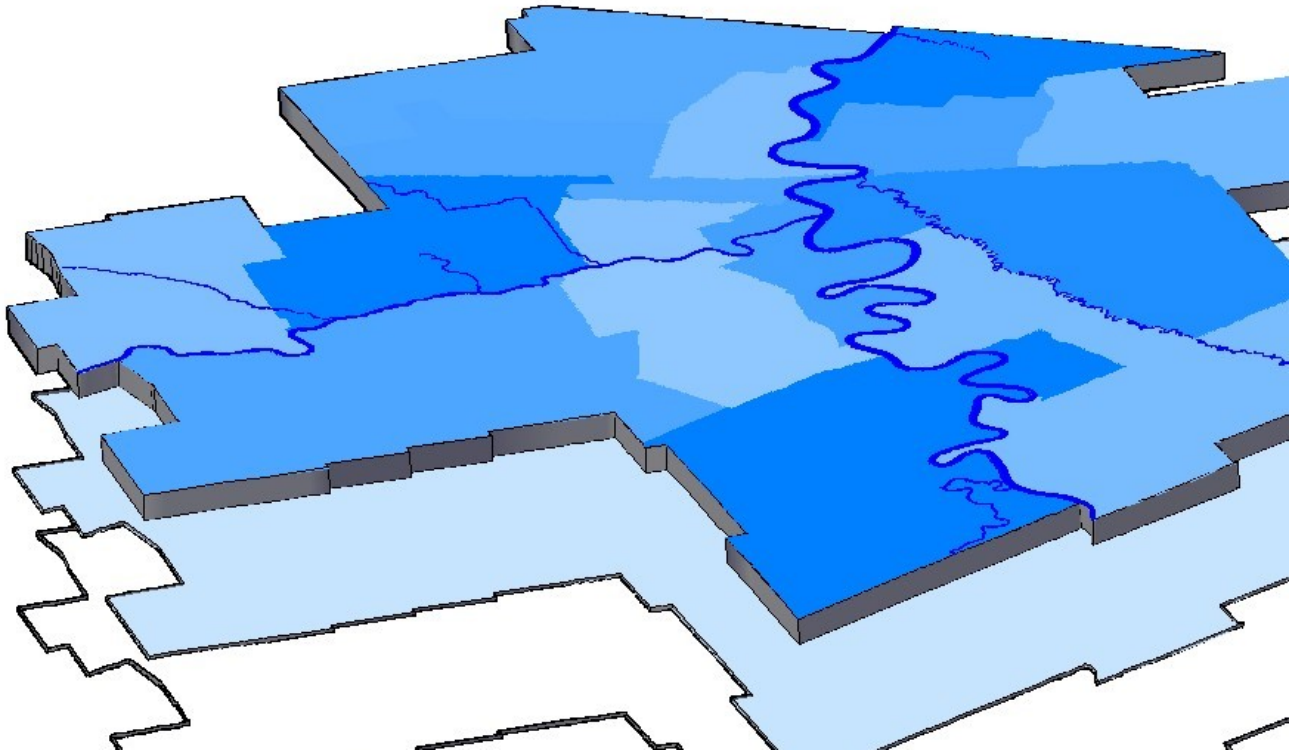

WWD CAD/GIS STANDARDS

Phase 1 - Capital Budget Renewals

Prepared by:
The Engineering Division
Water and Waste Department
City of Winnipeg March 10, 2023

TABLE OF CONTENTS

LIST OF ADDENDUM	I-IV
1.0 GENERAL.....	1-1
1.1 INTRODUCTION	1-1
1.2 PURPOSE	1-1
1.3 SCOPE	1-1
1.4 TERMINOLOGY.....	1-1
1.5 TEXT STYLES USED IN THIS DOCUMENT	1-2
2.0 WWD SOFTWARE ENVIRONMENT	2-1
2.1 AUTOCAD	2-1
2.2 VERSION.....	2-1
2.3 OTHER PROGRAMS.....	2-1
2.4 GEOGRAPHIC INFORMATION SYSTEM (GIS)	2-1
2.4.1 GIS Environment	2-1
3.0 PREPARING AUTOCAD DRAWINGS FOR THE WATER AND WASTE DEPARTMENT.....	3-1
3.1 BASIC REQUIREMENTS – DESIGN/CONSTRUCTION AND FINAL RECORD DRAWINGS.....	3-1
3.1.1 Design/Construction Drawing	3-1
3.1.2 Final Drawing Definitions:	3-1
3.2 FINAL RECORD DRAWINGS.....	3-2
3.2.1 Project Types	3-2
3.3 CADASTRAL BASE INFORMATION.....	3-3
3.4 PROTOTYPE DRAWINGS	3-3
3.4.1 Title/Cover Sheet.....	3-5
3.4.2 Legend/Drawing Index Sheets.....	3-7
3.4.3 Oversize ISO A1 (594 mm x 841 mm) Plan/Profile Sheet - Water.....	3-9
3.4.4 Oversize ISO A1 (594 mm x 841 mm) Plan/Profile Sheet - Sewer	3-12
3.4.5 Oversize ISO A1 (594 mm x 841 mm) Plan/Profile Sheet – Open Channel (Ditching)...	3-14
11" x 17" Sewer Sheet.....	3-16
3.4.6 Detail Sheets	3-20
3.5 TITLE BLOCK.....	3-22
3.6 GENERAL DRAFTING REQUIREMENTS	3-24
3.6.1 Drawing Orientation.....	3-27
3.6.2 Text Orientation	3-28
3.6.3 Caution Note for Other Utilities.....	3-29
3.6.4 Legend	3-30
3.6.5 Drawing Scales.....	3-32
4.0 LAYERS REQUIRED IN THE FINAL GIS DRAWING	4-1
4.1.1 Sewer	4-2
4.1.2 Water	4-4
4.1.3 Blocks and Symbols – General Information.....	4-5
4.1.4 AutoCAD to GIS Blocks or 'AG' Blocks.....	4-6
4.1.5 Symbol List	4-7
4.1.6 Service Charts	4-11
4.1.7 Dimensioning	4-13
4.1.8 Fonts	4-15
4.1.9 Linear Entities - Direction of Flow	4-18
4.1.10 Plot Styles	4-18
4.1.11 X-Refs and Aerial Images.....	4-18

4.1.12	Base Lines and Chainages	4-18
4.1.13	Survey	4-19
4.1.14	File Names	4-19
4.1.15	Details	4-19
5.0 STANDARD MEASUREMENTS OF WATER AND SEWER CUSTOMER CONNECTIONS		5-1
5.1	WATER CONNECTIONS: BUILDING SERVICE RECORD	5-2
5.1.1	Curb Stop.....	5-2
5.1.2	Corporation Stop	5-2
5.1.3	Tie-In at building	5-3
5.1.4	Couplers (unions)	5-3
5.1.5	Anodes	5-3
5.2	SEWER CONNECTIONS	5-10
5.2.1	Junction	5-10
5.2.2	Point of intersection at property line	5-10
5.2.3	Point of intersection at building	5-10
5.2.4	Fittings (Bends, Wye).....	5-10
5.2.5	Standpipe.....	5-11
6.0 REVISING A CONSTRUCTION DRAWING TO A RECORD DRAWING.....		6-1
6.1	REQUIREMENTS FOR A WATER OR SEWER RECORD DRAWING	6-2
6.1.1	Material Lists	6-3
6.1.1	Some Specific Requirements for Record Drawings	6-3
6.1.2	GIS Requirements.....	6-4
6.1.3	AUGMENTED (Combination of Complete Relining with EPR)	6-4
6.1.4	CIPP Lining	6-4
6.1.5	External Point Repairs (SD-022A and SD-022B)	6-5
6.1.6	Internal Point Repairs (TPR's or Trenchless Point Repairs).....	6-5
6.1.7	Sewer Main Renewal.....	6-5
6.1.8	Ditch Work or 'Open Channel'.....	6-6
6.1.9	Water Main Renewal.....	6-6
6.2	FINAL RECORD DRAWING EXAMPLES	6-7
6.2.1	Oversize ISO A1 (594 mm x 841 mm) Plan/Profile Record Drawing – Sewer	6-8
6.2.2	Oversize ISO A1 (594 mm x 841 mm) Plan/Profile Record Drawing – Open Channel (Ditching) 6-9	
6.2.3	11" x 17" Sewer Sheet Record Drawings	6-10
6.2.4	11" x 17" External Point Repair (EPR) and Trenchless Point Repair (TPR) Record Drawing 6-11	
6.2.5	11" x 17" Augmented Lining Record Drawing	6-12
6.3	FINAL GIS DRAWING EXAMPLES	6-13
6.3.1	Oversize ISO A1 (594 mm x 841 mm) GIS Record Drawing Water	6-14
6.3.2	Oversize ISO A1 (594 mm x 841 mm) GIS Record Drawing Open Channel (Ditching)..	6-15
7.0 SUBMITTING A RECORD DRAWING TO THE WWD		7-1
7.1	PRELIMINARY REVIEW	7-1
7.2	FINAL REVIEW	7-1
7.3	DIGITAL FILES	7-1
8.0 FAQ		8-1
9.0 SUMMARY - CHECKLIST		9-1
10.0 APPENDIX.....		10-1
APPENDIX A - TITLE/COVER SHEET - TITLE/COVER SHEET (A1).....		10-1

APPENDIX B- TITLE/COVER SHEET (11X17)	10-2
APPENDIX C - WATER INDEX CONSTRUCTION DRAWING (11X17)	10-3
APPENDIX D - SEWER INDEX CONSTRUCTION DRAWING (A1)	10-4
APPENDIX E - SEWER INDEX CONSTRUCTION DRAWING (11X17)	10-5
APPENDIX F - WATER CONSTRUCTION DRAWING (A1)	10-6
APPENDIX G - SEWER CONSTRUCTION DRAWING (A1)	10-7
APPENDIX H - OPEN CHANNEL CONSTRUCTION DRAWING (A1)	10-8
APPENDIX I - CIPP CONSTRUCTION DRAWING (11X17)	10-9
APPENDIX J - EPR/TPR CONSTRUCTION DRAWING (11X17)	10-10
APPENDIX K - AUGMENTATED CONSTRUCTION DRAWING (11X17)	10-11
APPENDIX L- DETAIL BASE DRAWING (A1)	10-12
APPENDIX M - DETAIL BASE DRAWING (11X17)	10-13
APPENDIX N - TITLE BLOCK	10-14
APPENDIX O - LEGEND (PART 1)	10-16
APPENDIX O (CONT.) - LEGEND	10-17
APPENDIX P - SYMBOL LIST (PART 1)	10-18
APPENDIX P (CON'T) – SYMBOL LIST (PART 3)	10-20
APPENDIX Q – PLOT STYLES	10-21
APPENDIX R - WATER RECORD DRAWING (A1)	10-22
APPENDIX S - SEWER RECORD DRAWING (A1)	10-23
APPENDIX T – OPEN CHANNEL RECORD DRAWING (A1)	10-24
APPENDIX U – CIPP RECORD DRAWING (11X17)	10-25
APPENDIX V- EPR/TPR RECORD DRAWING (11X17)	10-26
APPENDIX W – AUGMENTED RECORD DRAWING (11X17)	10-27
APPENDIX X – GIS WATER DRAWING	10-28
APPENDIX Y – GIS SEWER DRAWING	10-29
APPENDIX Z- GIS OPEN CHANNEL DRAWING	10-30
APPENDIX AA- GIS OPEN CHANNEL DRAWING	10-31
APPENDIX AA- GIS OPEN CHANNEL DRAWING	10-32

List of Addendum

1. Page 3-2, Section 3.2 Final Record Drawing
2. Page 3-2, Section 3.2.1 Project Types
3. Page 3-3, Section 3.3 Cadastral Base Information
4. Page 3-3, Section 3.4 Prototype drawings
5. Pages 3-9 to 3-10, Section 3.4.3 Oversize ISO A1 (594 mm x 841 mm) Plan/Profile Sheet – Water
6. Pages 3-12 to 3-13, Section 3.4.4 Oversize ISO A1 (594 mm x 841 mm) Plan/Profile Sheet Sewer
7. Pages 3-14 to 3-15, Section 3.4.5 Oversize ISO A1 (594 mm x 841 mm) Plan/Profile Sheet – Open Channel (Ditching)
8. Pages 3-7 to 3-8, Section 3.4.2 Legend
9. Pages 3-16 to 3-19, Section 3.4.6 11" x 17" Sewer Sheet
10. Page 3-22, Section 3.5 Title block
11. Page 3-24, Section 3.6 General Drafting Requirements
12. Page 3-32 Section 3.6.5 Drawing Scale
13. Page 4-7 to 4-8, Section 4.1.5 Symbol list.
14. Page 4-11, Section 4.1.6 Service charts
15. Page 4-13, Section 4.1.7 dimensioning
16. Pages 5-1 to 5-12, Section 5.0 to 5.2.5 (**New Section**)
17. Page 6-1, Section 6.0 Revising A Construction Drawing to A Record Drawing
18. Page 6-4, Section 6.1.2 GIS requirements
19. Pages 6-7 to 6-12, Section 6.2 Final Record Drawing Examples.
20. Page 7-1, Section 7.2 Final Review
21. Page 7-1, Section 7.3 Digital Files
22. Page 9-1, Section 9.0 Summary Check List
23. Page 11-1, Section 11.0 As-Built and Record Drawings (Removed)

1.0 GENERAL

1.1 INTRODUCTION

The City of Winnipeg's Water and Waste Department (WWD) develops these Standards in a phased approach. Phase 1 (this document) applies to Capital Budget renewal projects only, such as water main renewals. Upon implementation of Phase 1, Phase 2 will involve the addition of Standards for New Development Projects. Phase 3 of these Standards will involve the development of Standards for multi-discipline major Capital Projects such as plant expansions.

1.2 PURPOSE

The intent is to standardize the way electronic drawing files are produced and to make all drawing files, regardless of who produced them, similar in look and content. **This will reduce the challenges faced by the WWD in managing and manipulating disparate files and facilitate seamless integration with the Geographic Information System (GIS).**

Currently at the WWD, the disparity in the CAD files received precludes the use of automation for converting the information to GIS data. These Standards will facilitate a more seamless process.

These standards shall be used in all drawings that are produced using Computer Aided Drafting (CAD) for the WWD. Because of the rapidly changing technologies used in engineering design and drafting, this manual should be considered a "living" document, which will change as technologies change. These drawings will become permanent records of the distribution or collection system; therefore, these standards must be adhered to.

It is acknowledged by the WWD that consultants and design firms have existing workflows and processes already in place to produce AutoCAD drawings for the WWD. **Our aim is to disrupt existing workflows as little as possible.**

1.3 SCOPE

This manual covers the basic preparation of project plans for the WWD using CAD as the method of plan preparation for both the design/construction and post construction phase of the project. The elements covered in this manual are the WWD's CAD and GIS environments, general drafting conventions, the various prototype CAD drawings that should be used, the various types of projects this manual applies to, map projections, file naming, and the submission of record drawings.

1.4 TERMINOLOGY

Within this document:

- **"shall"** is used to express a requirement, e.g., a provision that the user is obliged to satisfy in order to comply with this specification
- **"should"** is used to express a recommendation or that which is advised but not required
- **"may"** is used to express an option or that which is permissible within the limits of this specification

1.5 TEXT STYLES USED IN THIS DOCUMENT

This document uses specific font text styles:

Normal text like this is used for all background and descriptive information.

Important notes for **quick reference** are inside a box like this.

Quotes from other sources/documents are in italics and indented like this.

References to other sections in this document are shown like this.

2.0 WWD SOFTWARE ENVIRONMENT

2.1 AUTOCAD

2.2 Version

Drawing files provided to the WWD in a digital format shall be produced in AutoCAD (.dwg) format and saved in the version presently being used by the WWD. Final GIS drawing files submitted shall be 100% AutoCAD drawing format and 100% editable. Third party fonts, hatch patterns, custom line types or shapefiles, shall not be used in Final GIS CAD files submitted to the Department. Files can be submitted on either DVD, CD-ROM, USB drive, or via the Consultant's FTP.

The version of AutoCAD being used by the WWD at the time that these standards were established is AutoCAD 2019 (or Civil 3D). These standards can only address those issues pertaining to this version of AutoCAD. Despite newer versions of AutoCAD now being available, projects shall be submitted in AutoCAD (or Civil 3D).

Once the WWD upgrades to a newer version of AutoCAD, that version shall be the official version. At that time, the Department shall determine if submittals produced using earlier versions are acceptable.

2.3 OTHER PROGRAMS

There are many programs available that run as adjuncts to AutoCAD and can help prepare CAD projects more efficiently (e.g. Civil 3D, Map 3D, etc.). These programs create new entity types, automate tasks, and can greatly aid in delivering a project in a timely manner. It is acknowledged that these programs are widely used throughout the industry and may be used for WWD projects. **However, the WWD shall require that the final GIS Record Drawings submitted are viewable with standard AutoCAD.**

2.4 GEOGRAPHIC INFORMATION SYSTEM (GIS)

2.4.1 GIS Environment

The WWD GIS environment currently consists of Intergraph's **Geo-Media Pro software with an Oracle 11g database**, and uses the following projection:

Universal Transverse Mercator (UTM), North American 1983 Datum (NAD 83) June 1990, Zone 14 North.

Implemented in 2002, the GIS has made digital data easily accessible; data is being employed by a large number of persons, not only in the WWD but in the City of Winnipeg at large, as well as outside agencies. The system is being used for analysis, planning, mapping, field location, and as an asset management/inventory tool. The data in the GIS is also being viewed enterprise wide via web application (iView). **For these reasons, the accuracy and completeness of the data is extremely important.**

These Standards will enable automation to be employed in converting the large number of CAD drawings received by the WWD into GIS data.

The information on record drawings received by the WWD ultimately becomes GIS data, and accounts for over 90% of the information currently being input. The importance of

receiving CAD record drawings in a consistent format, that also accurately reflects the work that was done, cannot be overstated.

3.0 PREPARING AUTOCAD DRAWINGS FOR THE WATER AND WASTE DEPARTMENT

3.1 BASIC REQUIREMENTS – DESIGN/CONSTRUCTION AND FINAL RECORD DRAWINGS

The main difference of this CAD-GIS Standard, from any previous standard is the requirement for the submission of a second final record drawing a Final GIS Drawing. The requirement for the Design/Construction drawing and Final Record Drawing have remained virtually the same. If the look of a typical drawing was acceptable before the implementation of these standards, chances are it will still be acceptable. Minor enhancements, such as Material list, shall be required.

It is acknowledged by the WWD that many consultants and design firms have existing workflows and processes already in place to produce AutoCAD drawings for the WWD. **We hope to disrupt these existing workflows as little as possible.**

3.1.1 Design/Construction Drawing

The WWD will provide guidelines and a prototype drawing before the design/tendering phase of a project. It is important that the look of this drawing, when submitted and printed as a PDF, is identical to the WWD prototype. The layers, symbols, and colors in the WWD prototype drawing may be used by the consultant/design firm in the creation of their drawing, or they may simply be used as a guideline.

The layers, colors, workflows, and adjunct software used to prepare the Construction/Design Drawings. Blocks are supplied by the WWD and it is strongly recommended that they be used, but if desired, internal blocks may be used as long as they resemble the current blocks provided.

Standard details shall be used when necessary to define work that will be done in the right of way in accordance to the City of Winnipeg.

The standards can be found at: <https://www.winnipeg.ca/matmgt/Spec/Default.stm>

The water and sewer services shall be measured and shown on the tables using the ***Standard Measurements for Water and Sewer Connections*** document (See section 5.1 – 5.4.5).

3.1.2 Final Drawing Definitions:

Record Drawing: Drawings referred to as "Record Drawings" are those prepared by the reviewing Professional Engineer after verifying in detail the actual conditions of the completed project.

As-Built Drawing: Drawings referred to as "As-Built" are prepared by a third party, or by the Professional Engineer using information furnished by the contractor or other field staff.

3.2 Final Record Drawings

There are two AutoCAD drawings required as final records of projects completed for the WWD.

The information contained in these drawings shall be oriented using the same datum as the WWD GIS: NAD 1983 June 1990.

1. Final Record Drawing:

This drawing will be used as the final legal record of the project. When submitted to the Department, this drawing shall be formatted in such a way so that the final PDF print of the AutoCAD drawing looks identical to the Department prototype drawing. The general look shall be followed. The line thicknesses, title blocks, fonts, etc. must be used. Layer names, colors, and symbols from the WWD Final Record Drawing prototype may be used in the completion of this drawing .

The layers, colors, workflows, and adjunct software used to prepare the Record Drawings. Blocks are supplied by the WWD and it is strongly recommended that they be used, but if desired, internal blocks may be used as long as they resemble the current blocks provided.

2. Final GIS Drawing:

This is a stripped-down representation of the work with minimal layers and detail, and will be used to enter the information into the GIS. When submitted to the WWD, this drawing shall have a minimum of objects and layers and be formatted in a very specific way in terms of its layers and content. When project work involves several drawings, whether clustered together geographically or contiguous in model space, these drawings shall be submitted as a single drawing file when possible.

The entities contained within this drawing will ultimately become GIS objects/layers. The layers and symbols in this drawing shall not be edited and are to be used 'as is.'

3.2.1 Project Types

Some of the projects types typically prepared for the WWD by consultants and covered by this document are:

- Combined Sewer Relief (SRS)
- Feeder mains
- Full segment sewer renewals
- Force mains
- Gate chambers
- Interceptor sewers
- Land drainage sewers
- Open channel (ditching)
- Outfall repairs
- Pumping stations
- Sewer renewal by CIPP lining/augmented lining, external point repairs (EPR), trenchless point repairs (TPR), stabilization
- Valve chambers
- Water main renewals

3.3 CADASTRAL BASE INFORMATION

- **Horizontal datum: Any and all data within shall be oriented in the NAD 83 June 1990 datum.** Base data shall not be moved spatially, and shall be retained in model space in its original UTM view. An exception to this would be an adjustment of the supplied water and sewer data to match surveyed results. Paper space and layout views shall be used to manipulate the data into a suitable drawing. These layouts shall follow the same standard naming convention provided by the WWD for the file names.
- **Vertical Datum: Any and all data within shall be oriented in the Vertical Datum: CGVD28 (HT2.0 Geoid).** Base data shall not be moved spatially, and shall be retained in model space in its original UTM view. An exception to this would be an adjustment of the supplied water and sewer data to match surveyed results. Paper space and layout views shall be used to manipulate the data into a suitable drawing. These layouts shall follow the same standard naming convention provided by the WWD for the file names.
- On large projects, where several drawings are needed to show continuous infrastructure, the base entities and cadastral data shall be continuous in model space. These entities shall not be "broken up," rotated, or edited in order to depict the specific sections of the project on individual drawings. Views, paper space and layouts shall be used to display the work.

3.4 PROTOTYPE DRAWINGS

The WWD will supply three digital prototype drawing sheets to consultants; they will be used as a guide in the preparation of water or sewer projects. The drawing file format for the prototype drawings will be in the WWD's current version of AutoCAD. A symbol library will be included with the prototype drawings.

For consultants/design firms who have established standards and workflows, some adjustment of existing processes will be needed. For those without established workflows, it is strongly encouraged that their processes adopt the WWD prototype drawings, layers, and symbols.

The three prototype drawings are:

- 1 **Design/Construction** – will be used as an example of the look, when submitted and printed as a PDF, which is required for the creation of drawings for the Construction/Design phase of the project. Layering and symbology are only recommendations (e.g., if a design firm already has a symbol that is identical in look to the hydrant symbol provided by the WWD, that symbol may be used).
- 2 **Final Record or As-Built Drawing** - will be used as an example of the look, when printed-- that is required for the creation of Final Record Drawings. Layering and symbology are suggested only (e.g., if a design firm already has a symbol that is identical in look to the hydrant provided by WWD, that symbol may be used).

It is important to note that the layers, colors, workflows, and adjunct software used to prepare the Design/Construction Drawings and the Final Record Drawings it is strongly recommended that they be used, but if desired, internal blocks may be used as long as they resemble the current blocks provided.

- 3 **Final GIS Drawing** - will contain the layering scheme and symbols to be used for the Final GIS Drawing. It shall be in model space only.

To facilitate seamless exchange with the WWD's GIS, the layers and symbols in this drawing shall not be edited and are to be used 'as is.' Also, the coordinate system shall be set to NAD 83 June 1990 Zone 14 North and the view to WORLD UCS.

Design/Drawing packages shall be prepared using drawing sheets set up for one of two sizes, depending on the type of project. The WWD shall supply full size, A1 (594 mm x 841 mm), prototype drawings for water projects or full segment sewer renewal projects; and 11" x 17" prototype drawings for sewer renewals by CIPP linings, external point repairs or trenchless point repairs. Examples can be found below.

The order of drawings in a design/drafting package is as follows:

- Title/Cover Sheet
- Legend/Drawing index sheet
- Plan/Profile Sheet (for renewal packages), or a Plan Sheet for sewer repairs and CIPP
- Detail Sheet

3.4.1 Title/Cover Sheet

All projects prepared for the Department shall have a Title Sheet. The Title Sheet shall be the first drawing in the set and shall contain a City of Winnipeg logo, the name of the Department, the Division responsible for the project, the project title, the project bid opportunity number and a contract number, if applicable. The title sheet shall contain a Key Map (if applicable), including the north arrow. The streets affected by the work shall be high-lighted in the Key Map. The scale of the Key Map will depend on the drawing size used for the project.

Oversize ISO A1 (594 mm x 841 mm) Landscape Title/Cover Sheet

Figure 1 below represents a typical A1 size title sheet. The coverage of the Key Map shall be sufficient to cover the project area, as well as give a general orientation of where the project area falls within the city while still insuring that street names are readable. The individual streets involved in the project should be high-lighted. If necessary, more than one key map can be used.

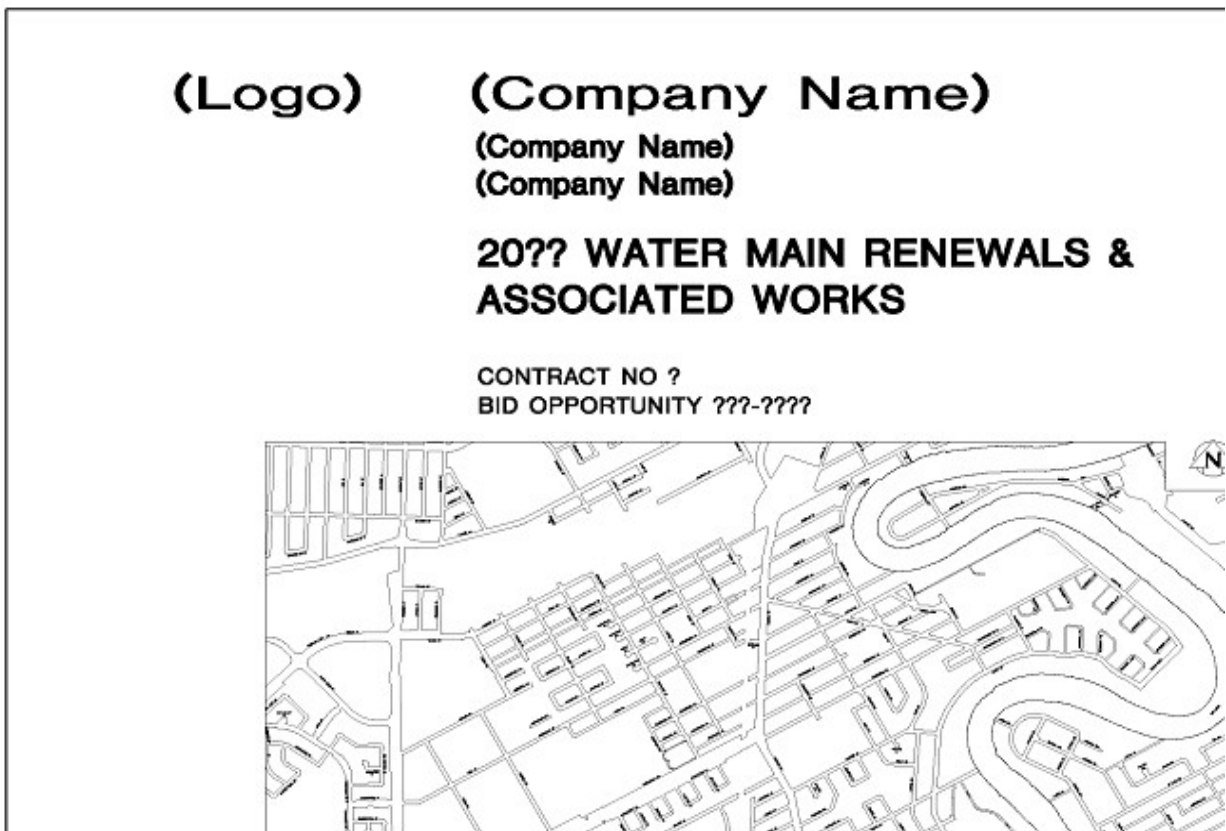

Figure 1
(For a larger view see Appendix A)

11"x 17" Title/Cover Sheet

Figure 2 below represents a typical 11x17 size title sheet. The coverage of the Key Map shall be sufficient to cover the project area, as well as to give a general orientation of where the project area falls within the city while still insuring that street names are readable. The individual streets involved in the project should be high-lighted. If necessary, more than one Key Map shall be used.

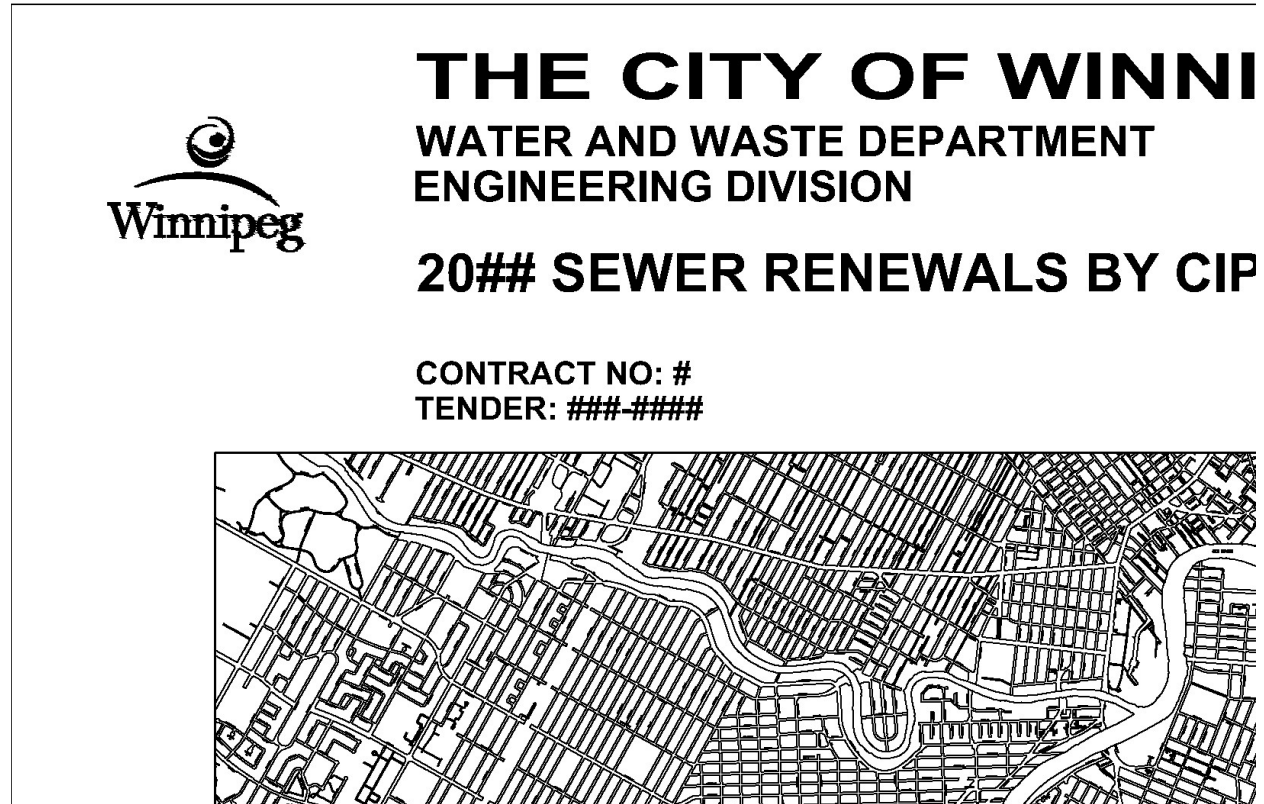

Figure 2
(For a larger view see Appendix B)

3.4.2 Legend/Drawing Index Sheets

All drawing packages prepared for the Department shall have a Legend/Drawing Index sheet. The Legend/Drawing Index sheet is the second drawing in the set and contains a list of all drawings, drawing title, drawing number and sheet numbers included. The Legend/Drawing Index also contains standard abbreviations, a legend of existing and proposed symbols and line types, and general construction notes.

Oversize ISO A1 (594 mm x 841 mm) Water Legend/Drawing Index Sheet

Figure 3a below represents a typical A1 Legend/Drawing Index sheet for water projects.

DRAWING INDEX			ABBREVIATIONS	DESCRIPTION
1	D-000000	COVER PAGE		WATER PIPE
2	D-000000	DRAWING INDEX, DESIGN NOTES, LEGEND, & ABBREVIATIONS		PIPE HYDRANT
3	D-000000	XXXXXX STREET – 100 E OF XXXXXX AVENUE TO 200.5 W OF XXXXXX BOULEVARD		VALVE
4	D-000000	XXXXXX STREET – 100 E OF XXXXXX AVENUE TO 200.5 W OF XXXXXX BOULEVARD		CURB STOP
5	D-000000	XXXXXX STREET – 100 E OF XXXXXX AVENUE TO 200.5 W OF XXXXXX BOULEVARD		RELOCATOR
6	D-000000	XXXXXX STREET – 100 E OF XXXXXX AVENUE TO 200.5 W OF XXXXXX BOULEVARD		COUPLING OR BEND
7	D-000000	XXXXXX STREET – 100 E OF XXXXXX AVENUE TO 200.5 W OF XXXXXX BOULEVARD		REDUCER
8	D-000000	XXXXXX STREET – 100 E OF XXXXXX AVENUE TO 200.5 W OF XXXXXX BOULEVARD		END OF PIPE
9	D-000000	XXXXXX STREET – 100 E OF XXXXXX AVENUE TO 200.5 W OF XXXXXX BOULEVARD		SEWER PIPE
10	D-000000	XXXXXX STREET – 100 E OF XXXXXX AVENUE TO 200.5 W OF XXXXXX BOULEVARD		MANHOLE
11	D-000000	XXXXXX STREET – 100 E OF XXXXXX AVENUE TO 200.5 W OF XXXXXX BOULEVARD		CUT-IN MANHOLE
12	D-000000	XXXXXX STREET – 100 E OF XXXXXX AVENUE TO 200.5 W OF XXXXXX BOULEVARD		CURB INLET
13	D-000000	XXXXXX STREET – 100 E OF XXXXXX AVENUE TO 200.5 W OF XXXXXX BOULEVARD		UNION
14	D-000000	XXXXXX STREET – 100 E OF XXXXXX AVENUE TO 200.5 W OF XXXXXX BOULEVARD		E-STOP
15	D-000000	XXXXXX STREET – 100 E OF XXXXXX AVENUE TO 200.5 W OF XXXXXX BOULEVARD		OLEFANT
16	D-000000	XXXXXX STREET – 100 E OF XXXXXX AVENUE TO 200.5 W OF XXXXXX BOULEVARD		SURVEY MARK
17	D-000000	XXXXXX STREET – 100 E OF XXXXXX AVENUE TO 200.5 W OF XXXXXX BOULEVARD		MARK
18	D-000000	XXXXXX STREET – 100 E OF XXXXXX AVENUE TO 200.5 W OF XXXXXX BOULEVARD		WIRE - CONDUITS
19	D-000000	XXXXXX STREET – 100 E OF XXXXXX AVENUE TO 200.5 W OF XXXXXX BOULEVARD		SEE CONDUITS
20	D-000000	XXXXXX STREET – 100 E OF XXXXXX AVENUE TO 200.5 W OF XXXXXX BOULEVARD		HYDRANT
21	D-000000	XXXXXX STREET – 100 E OF XXXXXX AVENUE TO 200.5 W OF XXXXXX BOULEVARD		HYDRANT POLE
22	D-000000	XXXXXX STREET – 100 E OF XXXXXX AVENUE TO 200.5 W OF XXXXXX BOULEVARD		LAMP STANDARDS
23	D-000000	XXXXXX STREET – 100 E OF XXXXXX AVENUE TO 200.5 W OF XXXXXX BOULEVARD		HYDRANT POLE STREET LIGHTING
24	D-000000	XXXXXX STREET – 100 E OF XXXXXX AVENUE TO 200.5 W OF XXXXXX BOULEVARD		POLE
25	D-000000	XXXXXX STREET – 100 E OF XXXXXX AVENUE TO 200.5 W OF XXXXXX BOULEVARD		OFF ANCHOR
26	D-000000	XXXXXX STREET – 100 E OF XXXXXX AVENUE TO 200.5 W OF XXXXXX BOULEVARD		M.I.S. POLE
27	D-000000	XXXXXX STREET – 100 E OF XXXXXX AVENUE TO 200.5 W OF XXXXXX BOULEVARD		PERMITAL OR HOSE
28	D-000000	XXXXXX STREET – 100 E OF XXXXXX AVENUE TO 200.5 W OF XXXXXX BOULEVARD		CONCRETE
29	D-000000	XXXXXX STREET – 100 E OF XXXXXX AVENUE TO 200.5 W OF XXXXXX BOULEVARD		ASBESTOS CEMENT
30	D-000000	XXXXXX STREET – 100 E OF XXXXXX AVENUE TO 200.5 W OF XXXXXX BOULEVARD		VERIFIED CLAY
31	D-000000	XXXXXX STREET – 100 E OF XXXXXX AVENUE TO 200.5 W OF XXXXXX BOULEVARD		CAST IRON
32	D-000000	XXXXXX STREET – 100 E OF XXXXXX AVENUE TO 200.5 W OF XXXXXX BOULEVARD		DUCTILE IRON
33	D-000000	XXXXXX STREET – 100 E OF XXXXXX AVENUE TO 200.5 W OF XXXXXX BOULEVARD		POLYETHYLENE GLASSER
34	D-000000	XXXXXX STREET – 100 E OF XXXXXX AVENUE TO 200.5 W OF XXXXXX BOULEVARD		HIGH DENSITY POLYETHYLENE
35	D-000000	XXXXXX STREET – 100 E OF XXXXXX AVENUE TO 200.5 W OF XXXXXX BOULEVARD		PRESSURIZED CONCRETE (VULCANIZED RUBBER)
36	D-000000	XXXXXX STREET – 100 E OF XXXXXX AVENUE TO 200.5 W OF XXXXXX BOULEVARD		FEDERMAN
37	D-000000	XXXXXX STREET – 100 E OF XXXXXX AVENUE TO 200.5 W OF XXXXXX BOULEVARD		FORCE MAIN (PRESSURIZED SEWER MAIN)
38	D-000000	XXXXXX STREET – 100 E OF XXXXXX AVENUE TO 200.5 W OF XXXXXX BOULEVARD		
39	D-000000	XXXXXX STREET – 100 E OF XXXXXX AVENUE TO 200.5 W OF XXXXXX BOULEVARD		
40	D-000000	XXXXXX STREET – 100 E OF XXXXXX AVENUE TO 200.5 W OF XXXXXX BOULEVARD		
41	D-000000	XXXXXX STREET – 100 E OF XXXXXX AVENUE TO 200.5 W OF XXXXXX BOULEVARD		

HATCH PATTERNS	
	EARTH OR GROUND ABOVE PIPE
	SAND OR OTHER FINE MATERIAL
	CONCRETE

CONSTRUCTION NOTES

1. DISPOSE EXISTING WATERMAIN & CONFIRM INVERTS PRIOR TO CONSTRUCTION.
2. LOCATION OF ALL SERVICES TO BE CONFIRMED IN THE FIELD.
3. INSTALL WATERMAIN BY TRENCHLESS METHODS.
4. TRENCHES AND EXCAVATIONS WITHIN 1 METRE OF A PAVED AREA INCLUDING SIDEWALKS SHALL BE CLASS 3 BACKFILL.
5. ALL MATERIALS SHALL CONFORM TO THE CITY OF WINNIPEG STANDARD CONSTRUCTION SPECIFICATIONS.
6. MINIMUM COVER TO TOP OF WATERMAIN SHALL BE 2.4 M.
7. REPLACE ALL EXISTING LEAD SERVICES FROM PROPOSED WATERMAIN TO E.
8. NOTIFY ALL AFFECTED RESIDENTS AND BUSINESSES 24 HOURS IN ADVANCE OF ANY WATER SHUTDOWNS OR DISRUPTION OF SERVICE.

DESCRIPTION	
WATER PIPE	
PIPE HYDRANT	
VALVE	
CURB STOP	
RELOCATOR	
COUPLING OR BEND	
REDUCER	
END OF PIPE	
SEWER PIPE	
UNPAVED GROUND SURFACE	
PAVED GROUND SURFACE – E PIPE	
CUTTER (SOUTH AND WEST)	
CUTTER (NORTH AND EAST)	
E-STOP (NORTH AND WEST)	
E-STOP (SOUTH AND EAST)	
STRUCTURE	

Figure 3a
(For a larger view see Appendix C)

Oversize ISO A1 (594 mm x 841 mm) Sewer Legend/Drawing Index Sheet

Figure 3b below represents a typical A1 Legend/Drawing Index sheet for sewer projects.

DRAWING INDEX			ABBREVIATIONS		LEGAL
SHEET NUMBER	CITY OF WINNIPEG DRAWING NUMBER	DRAWING TITLE			DESCRIPTION
1	#####	COVER PAGE			WASTE WATER SEWER
2	#####	DRAWING INDEX, DESIGN NOTES, LEGEND, & ABBREVIATIONS	CS	COVERED SEWER	WATER PIPE
3	#####	XXXXXX STREET - 2ND MH E OF XXXXXX AVENUE TO 3RD MH E OF XXXXXX BOULEVARD	LSB	LOW SIDEWALK SEWER	HYDRANT TOP
4	#####	XXXXXX STREET - 2ND MH E OF XXXXXX AVENUE TO 3RD MH E OF XXXXXX BOULEVARD	E	PROPERTY LINE	VALVE
5	#####	XXXXXX STREET - 2ND MH E OF XXXXXX AVENUE TO 3RD MH E OF XXXXXX BOULEVARD	SLS	COVER LINE	CURB STOP
6	#####	XXXXXX STREET - 2ND MH E OF XXXXXX AVENUE TO 3RD MH E OF XXXXXX BOULEVARD	RA	REAR MARK	REDUCTION
7	#####	XXXXXX STREET - 2ND MH E OF XXXXXX AVENUE TO 3RD MH E OF XXXXXX BOULEVARD	TS	TEST HOLE	COURING OR REDUCER
8	#####	XXXXXX STREET - 2ND MH E OF XXXXXX AVENUE TO 3RD MH E OF XXXXXX BOULEVARD	ELEV	ELEVATION	CROSS
9	#####	XXXXXX STREET - 2ND MH E OF XXXXXX AVENUE TO 3RD MH E OF XXXXXX BOULEVARD	SH	SHOULDER	8800 - 11.20', 21.0', 45', 60'
10	#####	XXXXXX STREET - 2ND MH E OF XXXXXX AVENUE TO 3RD MH E OF XXXXXX BOULEVARD	MA	MANHOLE	THE
11	#####	XXXXXX STREET - 2ND MH E OF XXXXXX AVENUE TO 3RD MH E OF XXXXXX BOULEVARD	MAX	MAXIMUM	NOTICAL SEND
12	#####	XXXXXX STREET - 2ND MH E OF XXXXXX AVENUE TO 3RD MH E OF XXXXXX BOULEVARD	ST	STREET LIGHTING	INDE
13	#####	XXXXXX STREET - 2ND MH E OF XXXXXX AVENUE TO 3RD MH E OF XXXXXX BOULEVARD	TS	TRAFFIC SIGNALS	REPAIR MARKER
14	#####	XXXXXX STREET - 2ND MH E OF XXXXXX AVENUE TO 3RD MH E OF XXXXXX BOULEVARD	AS	ASPHALTED	FLUP
15	#####	XXXXXX STREET - 2ND MH E OF XXXXXX AVENUE TO 3RD MH E OF XXXXXX BOULEVARD	BD	BUILDING	SEWER PIPE
16	#####	XXXXXX STREET - 2ND MH E OF XXXXXX AVENUE TO 3RD MH E OF XXXXXX BOULEVARD	HL	HOUSE LATERAL	MANHOLE
17	#####	XXXXXX STREET - 2ND MH E OF XXXXXX AVENUE TO 3RD MH E OF XXXXXX BOULEVARD	CM	CONCRETE	CATCH BASIN
18	#####	XXXXXX STREET - 2ND MH E OF XXXXXX AVENUE TO 3RD MH E OF XXXXXX BOULEVARD	OP	OPEN	CURB INLET
19	#####	XXXXXX STREET - 2ND MH E OF XXXXXX AVENUE TO 3RD MH E OF XXXXXX BOULEVARD	OP	OPEN	INJECTION
20	#####	XXXXXX STREET - 2ND MH E OF XXXXXX AVENUE TO 3RD MH E OF XXXXXX BOULEVARD	OP	OPEN	E DITCH
21	#####	XXXXXX STREET - 2ND MH E OF XXXXXX AVENUE TO 3RD MH E OF XXXXXX BOULEVARD	OP	OPEN	VALVE
22	#####	XXXXXX STREET - 2ND MH E OF XXXXXX AVENUE TO 3RD MH E OF XXXXXX BOULEVARD	OP	OPEN	BLIND
23	#####	XXXXXX STREET - 2ND MH E OF XXXXXX AVENUE TO 3RD MH E OF XXXXXX BOULEVARD	OP	OPEN	BLIND
24	#####	XXXXXX STREET - 2ND MH E OF XXXXXX AVENUE TO 3RD MH E OF XXXXXX BOULEVARD	OP	OPEN	BLIND
25	#####	XXXXXX STREET - 2ND MH E OF XXXXXX AVENUE TO 3RD MH E OF XXXXXX BOULEVARD	OP	OPEN	BLIND
26	#####	XXXXXX STREET - 2ND MH E OF XXXXXX AVENUE TO 3RD MH E OF XXXXXX BOULEVARD	OP	OPEN	BLIND
27	#####	XXXXXX STREET - 2ND MH E OF XXXXXX AVENUE TO 3RD MH E OF XXXXXX BOULEVARD	OP	OPEN	BLIND
28	#####	XXXXXX STREET - 2ND MH E OF XXXXXX AVENUE TO 3RD MH E OF XXXXXX BOULEVARD	OP	OPEN	BLIND
29	#####	XXXXXX STREET - 2ND MH E OF XXXXXX AVENUE TO 3RD MH E OF XXXXXX BOULEVARD	OP	OPEN	BLIND
30	#####	XXXXXX STREET - 2ND MH E OF XXXXXX AVENUE TO 3RD MH E OF XXXXXX BOULEVARD	OP	OPEN	BLIND
31	#####	XXXXXX STREET - 2ND MH E OF XXXXXX AVENUE TO 3RD MH E OF XXXXXX BOULEVARD	OP	OPEN	BLIND
32	#####	XXXXXX STREET - 2ND MH E OF XXXXXX AVENUE TO 3RD MH E OF XXXXXX BOULEVARD	OP	OPEN	BLIND
33	#####	XXXXXX STREET - 2ND MH E OF XXXXXX AVENUE TO 3RD MH E OF XXXXXX BOULEVARD	OP	OPEN	BLIND
34	#####	XXXXXX STREET - 2ND MH E OF XXXXXX AVENUE TO 3RD MH E OF XXXXXX BOULEVARD	OP	OPEN	BLIND
35	#####	XXXXXX STREET - 2ND MH E OF XXXXXX AVENUE TO 3RD MH E OF XXXXXX BOULEVARD	OP	OPEN	BLIND
36	#####	XXXXXX STREET - 2ND MH E OF XXXXXX AVENUE TO 3RD MH E OF XXXXXX BOULEVARD	OP	OPEN	BLIND
37	#####	XXXXXX STREET - 2ND MH E OF XXXXXX AVENUE TO 3RD MH E OF XXXXXX BOULEVARD	OP	OPEN	BLIND
38	#####	XXXXXX STREET - 2ND MH E OF XXXXXX AVENUE TO 3RD MH E OF XXXXXX BOULEVARD	OP	OPEN	BLIND
39	#####	XXXXXX STREET - 2ND MH E OF XXXXXX AVENUE TO 3RD MH E OF XXXXXX BOULEVARD	OP	OPEN	BLIND
40	#####	XXXXXX STREET - 2ND MH E OF XXXXXX AVENUE TO 3RD MH E OF XXXXXX BOULEVARD	OP	OPEN	BLIND
41	#####	XXXXXX STREET - 2ND MH E OF XXXXXX AVENUE TO 3RD MH E OF XXXXXX BOULEVARD	OP	OPEN	BLIND

HATCH PATTERNS		CONSTRUCTION NOTES	LEGAL
	EARTH OR GROUND ABOVE PIPE	1. ALL PIPE SHALL HAVE CLASS B - TYPE 2 BEDDING	DESCRIPTION
	SAND OR OTHER FINE MATERIAL	2. INSTALL SEWER BY TRENCHLESS METHODS.	WASTE PIPE
	CONCRETE	3. CONFIRM THE LOCATION OF ALL SEWER SERVICES.	HYDRANT TOP
		4. BACKFILL UNDER PAVEMENT, IN SIDEWALKS, & WITHIN 1.0 OF PAVEMENT TO BE CLASS 3.	VALVE
		5. BACKFILL IN BOULEVARD TO BE CLASS 5.	TEE OR CROSS
		6. RENEW SEWER SERVICES TO E.	COURING OR REDUCER
		7. INSTALL SEWER SERVICE RISERS TO ELEVATION WHERE MINIMUM SLOPE OF 1% IS MAINTAINED FOR ALL SERVICES.	REDUCTION
			END OF PIPE
			SEWER PIPE
			UNPAVED GROUND SURFACE
			PAVED GROUND SURFACE - E PIPE
			(UTTER NORTH AND WEST)
			UTTER (EAST AND EAST)
			E DITCH (NORTH AND WEST)
			E DITCH (SOUTH AND EAST)
			STRUCTURE

Figure 3b
(For a larger view see Appendix D)

11" x 17" Sewer Legend/Drawing Index Sheet

Figure 4 below represents a typical 11" x 17" Legend/Drawing Index sheet.

DRAWING INDEX			ABBREVIATIONS		
SHEET NUMBER	CITY OF WINNIPEG DRAWING NUMBER	DRAWING TITLE	SYM	DESCRIPTION	DESCRIPTION
1	#####	COVER PAGE	SEW	SEWER SERVICE	SEWER SERVICE
2	#####	DRAWING INDEX, DESIGN NOTES, LEGEND, & ABBREVIATIONS	AS	ASBESTOS	ASBESTOS
3	#####	XXXXXX STREET - 100 E OF XXXXXXX AVENUE TO 200.5 W OF XXXXX BOULEVARD	LS	LEAD SERVICE	LEAD SERVICE
4	#####	XXXXXX STREET - 100 E OF XXXXXXX AVENUE TO 200.5 W OF XXXXX BOULEVARD	LS	LEAD SERVICE	LEAD SERVICE
5	#####	XXXXXX STREET - 100 E OF XXXXXXX AVENUE TO 200.5 W OF XXXXX BOULEVARD	LS	LEAD SERVICE	LEAD SERVICE
6	#####	XXXXXX STREET - 100 E OF XXXXXXX AVENUE TO 200.5 W OF XXXXX BOULEVARD	LS	LEAD SERVICE	LEAD SERVICE
7	#####	XXXXXX STREET - 100 E OF XXXXXXX AVENUE TO 200.5 W OF XXXXX BOULEVARD	LS	LEAD SERVICE	LEAD SERVICE
8	#####	XXXXXX STREET - 100 E OF XXXXXXX AVENUE TO 200.5 W OF XXXXX BOULEVARD	LS	LEAD SERVICE	LEAD SERVICE
9	#####	XXXXXX STREET - 100 E OF XXXXXXX AVENUE TO 200.5 W OF XXXXX BOULEVARD	LS	LEAD SERVICE	LEAD SERVICE
10	#####	XXXXXX STREET - 100 E OF XXXXXXX AVENUE TO 200.5 W OF XXXXX BOULEVARD	LS	LEAD SERVICE	LEAD SERVICE
11	#####	XXXXXX STREET - 100 E OF XXXXXXX AVENUE TO 200.5 W OF XXXXX BOULEVARD	LS	LEAD SERVICE	LEAD SERVICE
12	#####	XXXXXX STREET - 100 E OF XXXXXXX AVENUE TO 200.5 W OF XXXXX BOULEVARD	LS	LEAD SERVICE	LEAD SERVICE
13	#####	XXXXXX STREET - 100 E OF XXXXXXX AVENUE TO 200.5 W OF XXXXX BOULEVARD	LS	LEAD SERVICE	LEAD SERVICE
14	#####	XXXXXX STREET - 100 E OF XXXXXXX AVENUE TO 200.5 W OF XXXXX BOULEVARD	LS	LEAD SERVICE	LEAD SERVICE
15	#####	XXXXXX STREET - 100 E OF XXXXXXX AVENUE TO 200.5 W OF XXXXX BOULEVARD	LS	LEAD SERVICE	LEAD SERVICE
16	#####	XXXXXX STREET - 100 E OF XXXXXXX AVENUE TO 200.5 W OF XXXXX BOULEVARD	LS	LEAD SERVICE	LEAD SERVICE
17	#####	XXXXXX STREET - 100 E OF XXXXXXX AVENUE TO 200.5 W OF XXXXX BOULEVARD	LS	LEAD SERVICE	LEAD SERVICE
18	#####	XXXXXX STREET - 100 E OF XXXXXXX AVENUE TO 200.5 W OF XXXXX BOULEVARD	LS	LEAD SERVICE	LEAD SERVICE
19	#####	XXXXXX STREET - 100 E OF XXXXXXX AVENUE TO 200.5 W OF XXXXX BOULEVARD	LS	LEAD SERVICE	LEAD SERVICE
20	#####	XXXXXX STREET - 100 E OF XXXXXXX AVENUE TO 200.5 W OF XXXXX BOULEVARD	LS	LEAD SERVICE	LEAD SERVICE
21	#####	XXXXXX STREET - 100 E OF XXXXXXX AVENUE TO 200.5 W OF XXXXX BOULEVARD	LS	LEAD SERVICE	LEAD SERVICE
22	#####	XXXXXX STREET - 100 E OF XXXXXXX AVENUE TO 200.5 W OF XXXXX BOULEVARD	LS	LEAD SERVICE	LEAD SERVICE
23	#####	XXXXXX STREET - 100 E OF XXXXXXX AVENUE TO 200.5 W OF XXXXX BOULEVARD	LS	LEAD SERVICE	LEAD SERVICE
24	#####	XXXXXX STREET - 100 E OF XXXXXXX AVENUE TO 200.5 W OF XXXXX BOULEVARD	LS	LEAD SERVICE	LEAD SERVICE
25	#####	XXXXXX STREET - 100 E OF XXXXXXX AVENUE TO 200.5 W OF XXXXX BOULEVARD	LS	LEAD SERVICE	LEAD SERVICE
26	#####	XXXXXX STREET - 100 E OF XXXXXXX AVENUE TO 200.5 W OF XXXXX BOULEVARD	LS	LEAD SERVICE	LEAD SERVICE
27	#####	XXXXXX STREET - 100 E OF XXXXXXX AVENUE TO 200.5 W OF XXXXX BOULEVARD	LS	LEAD SERVICE	LEAD SERVICE
28	#####	XXXXXX STREET - 100 E OF XXXXXXX AVENUE TO 200.5 W OF XXXXX BOULEVARD	LS	LEAD SERVICE	LEAD SERVICE
29	#####	XXXXXX STREET - 100 E OF XXXXXXX AVENUE TO 200.5 W OF XXXXX BOULEVARD	LS	LEAD SERVICE	LEAD SERVICE
30	#####	XXXXXX STREET - 100 E OF XXXXXXX AVENUE TO 200.5 W OF XXXXX BOULEVARD	LS	LEAD SERVICE	LEAD SERVICE
31	#####	XXXXXX STREET - 100 E OF XXXXXXX AVENUE TO 200.5 W OF XXXXX BOULEVARD	LS	LEAD SERVICE	LEAD SERVICE
32	#####	XXXXXX STREET - 100 E OF XXXXXXX AVENUE TO 200.5 W OF XXXXX BOULEVARD	LS	LEAD SERVICE	LEAD SERVICE
33	#####	XXXXXX STREET - 100 E OF XXXXXXX AVENUE TO 200.5 W OF XXXXX BOULEVARD	LS	LEAD SERVICE	LEAD SERVICE
34	#####	XXXXXX STREET - 100 E OF XXXXXXX AVENUE TO 200.5 W OF XXXXX BOULEVARD	LS	LEAD SERVICE	LEAD SERVICE
35	#####	XXXXXX STREET - 100 E OF XXXXXXX AVENUE TO 200.5 W OF XXXXX BOULEVARD	LS	LEAD SERVICE	LEAD SERVICE
36	#####	XXXXXX STREET - 100 E OF XXXXXXX AVENUE TO 200.5 W OF XXXXX BOULEVARD	LS	LEAD SERVICE	LEAD SERVICE
37	#####	XXXXXX STREET - 100 E OF XXXXXXX AVENUE TO 200.5 W OF XXXXX BOULEVARD	LS	LEAD SERVICE	LEAD SERVICE
38	#####	XXXXXX STREET - 100 E OF XXXXXXX AVENUE TO 200.5 W OF XXXXX BOULEVARD	LS	LEAD SERVICE	LEAD SERVICE
39	#####	XXXXXX STREET - 100 E OF XXXXXXX AVENUE TO 200.5 W OF XXXXX BOULEVARD	LS	LEAD SERVICE	LEAD SERVICE
40	#####	XXXXXX STREET - 100 E OF XXXXXXX AVENUE TO 200.5 W OF XXXXX BOULEVARD	LS	LEAD SERVICE	LEAD SERVICE
41	#####	XXXXXX STREET - 100 E OF XXXXXXX AVENUE TO 200.5 W OF XXXXX BOULEVARD	LS	LEAD SERVICE	LEAD SERVICE

Figure 4
(For a larger view see Appendix E)

3.4.3 Oversize ISO A1 (594 mm x 841 mm) Plan/Profile Sheet - Water

Figure 5 on the following page, is an example of a design drawing for a water main renewal using an A1 size plan/profile sheet. An example of an A1 size water main renewal drawing shall be included with these standards.

In general, the following information shall be shown in the plan portion of the drawing:

- All existing utilities and appurtenances (e.g. manholes, chambers, valves), including water and sewer mains that fall within the street right-of-way.
- All existing water and sewer service connections; including shut-off valves (curb stops) and a water service table showing address, size, material and all location information for each service.
- When connecting to an existing main, indicate how it was connected. If a new PVC main is being connected to an existing metallic main, a coupling type shall be stated (e.g. Robar/Romac/Ford). When connecting to another PVC main, you can connect with bell to spigot or a PVC coupling. If a PVC coupling is used, the type must be indicated, either slip collar or slider coupling. Regardless of the kind of coupling used, the same block shall represent all types.

- Water valve closing direction note
- All property information such as property lines for the street right-of-way's, street names, lot lines, addresses (or lot, block and plan numbers), survey monuments, and bars.
- All topographic information that falls within a street right-of-way, such as street curb, poles, trees, and sidewalks etc.
- Dimensions (off-set from property lines), for all existing utilities and street rights-of-way.
- All proposed design (in bold), including proposed appurtenances, off-set dimensions from property lines, a description of the pipe, and construction notes specific to the drawing.
- Note: general construction notes shall be shown on the Legend/Drawing Index sheet.
- All proposed elevations shall be to three significant figures.
- Blow-up details clarifying congested design such as a tie-in to an existing water main. Note: details are primarily used for design that cannot be illustrated on the profile because it does not follow the horizontal design.
- Include water service table, the tables shall be unique to the drawing. If this is not possible, a reference to the drawing is needed.
- If at all possible, include a materials list, and shall be unique to the drawing. If this is not possible, a reference to the drawing is needed
- Include all survey information related to the project
- Ensure all text is on the proper layers (Sewer=Text_Sewer, Water=Text_Water, Utilities=Text_Misc)
- Pipe ends are used when a drawing has existing infrastructure that extends beyond the limits, or when the proposed pipes continue on another drawing where the stationing does not exist.
- Include any features that will be abandoned; once work is completed (as-built phase), change all abandoned features to abandon layers.
- No future works shall be on the drawing.
- North arrow, scale bar, a note describing the chainage applicable to the drawing, metric note and suitable cautionary and warning notes, index reference note, valve closing direction, and any table references are to shall be shown.
- The drawing shall be stamped with the seal of a professional engineer. The seal shall be signed and dated.
- Match lines with stationing shown to two decimal places
- Continuation notes

The following information shall be shown in the profile portion of the drawing:

- All existing water and sewer mains, including size and material
- Existing rim and invert elevations for existing sewer manholes
- Inverts for the existing water main, if known
- Chainage locations shall be noted for all existing water and sewer appurtenances, as well as for all proposed water appurtenances such as tees, valves and hydrant assemblies
- The proposed pipe design including, proposed size and material as well as proposed inverts (to three significant figures)
- Match lines with stationing shown to two decimal places

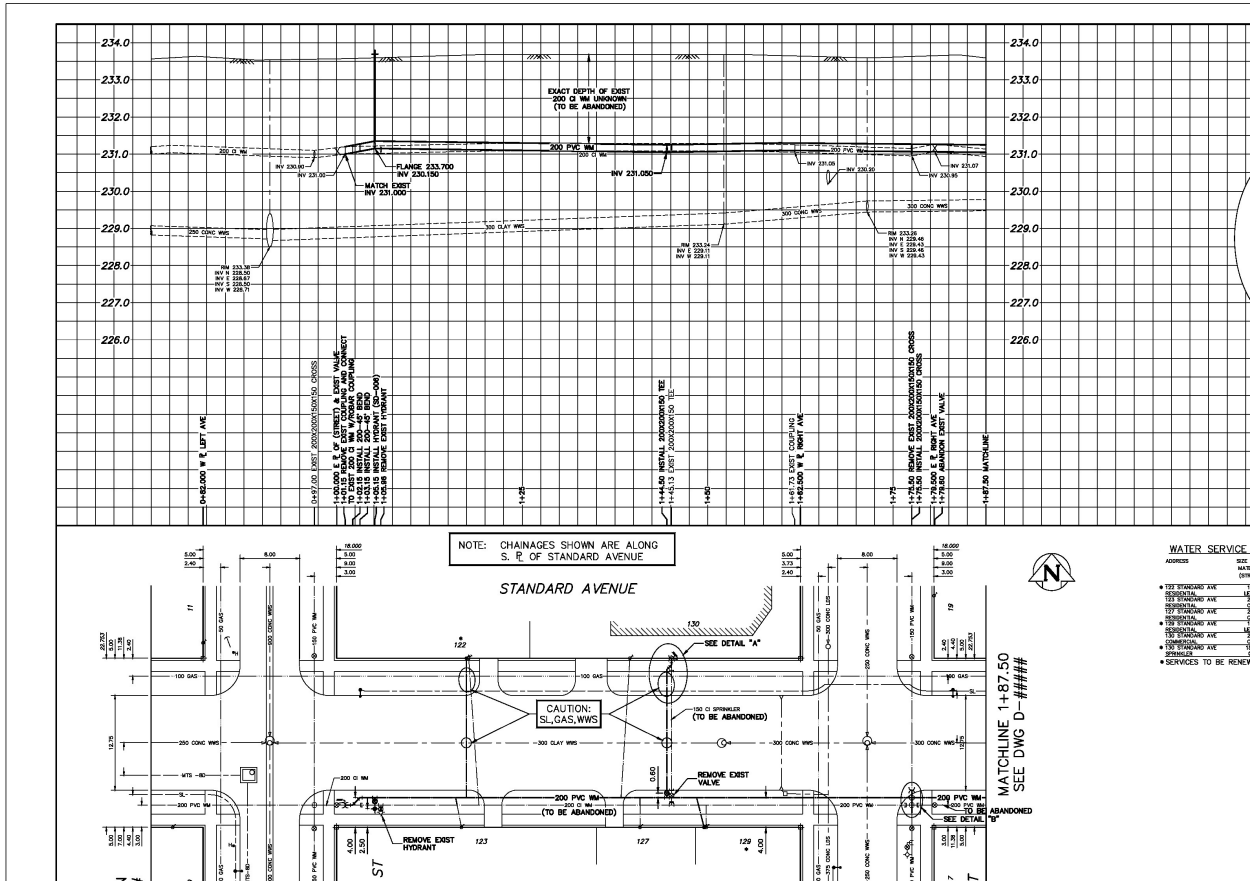

Figure 5
 (For a larger view see Appendix F)

3.4.4 Oversize ISO A1 (594 mm x 841 mm) Plan/Profile Sheet - Sewer

Figure 6, on the following page, is an example of a design for a full segment sewer renewal drawn on an A1 size plan/profile sheet. An example of an A1 size sewer main renewal drawing shall be included with these standards.

Similar to the water main renewal example above, the following information shall be shown in the plan portion of the drawing:

- All existing utilities and appurtenances (e.g. manholes, chambers, valves), including water and sewer that fall within the street right-of-way.
- All existing water and sewer service connections; including shut-off valves (curb stops) and a water service table and sewer service table showing address, size, material, and all location information for each service.
- Existing Manholes shall have their asset numbers included in the chainage on the profile.
- A sewer junction table, showing location information for each sewer junction shall also be shown, in addition to a sewer service table.
- All property information such as property lines for the street right-of-way's, street names, lot lines, addresses (or lot, block and plan numbers) All topographic information that falls within a street right-of-way, such as street curb, poles, trees, and sidewalks, etc..
- Dimensions (off-set from property lines) for all existing utilities and street rights-of-way
- All proposed elevations shall be to three significant figures.
- All proposed design (in bold), including proposed appurtenances, off-set dimensions from property line, description of pipe, and construction notes specific to the drawing.
- Note: General construction notes shall be shown on the Legend/Drawing Index sheet.
- Include all survey information related to the project.
- Ensure all text is on the proper layers (Sewer=Text_Sewer, Water=Text_Water, Utilities=Text_Misc)
- Include any abandoned features; once work is completed (as-built phase), change all existing features to abandon layers.
- No future works shall be on the drawing.
- A north arrow, scale bar, a note describing the chainage applicable to the drawing, metric note and suitable cautionary and warning notes, index reference note, and any sewer table references are to shall be shown.
- The drawing shall be stamped with the seal of a professional engineer. The seal shall be signed and dated.
- If needed Match lines with stationing shown to two decimal places
- If needed Continuation notes
- Flow arrows (use existing blocks)

The following information shall be shown in the profile portion of the drawing:

- Identification of the geodetic datum
- All existing water and sewer mains, including size and material
- Existing rim and invert elevations for existing sewer manholes
- Inverts for the existing water main, if known
- Chainage locations shall be noted for all existing and proposed sewer manholes
- Complete proposed pipe design including, proposed size and material as well as proposed inverts (to three decimal places)
- Match lines with stationing shown to two decimal places

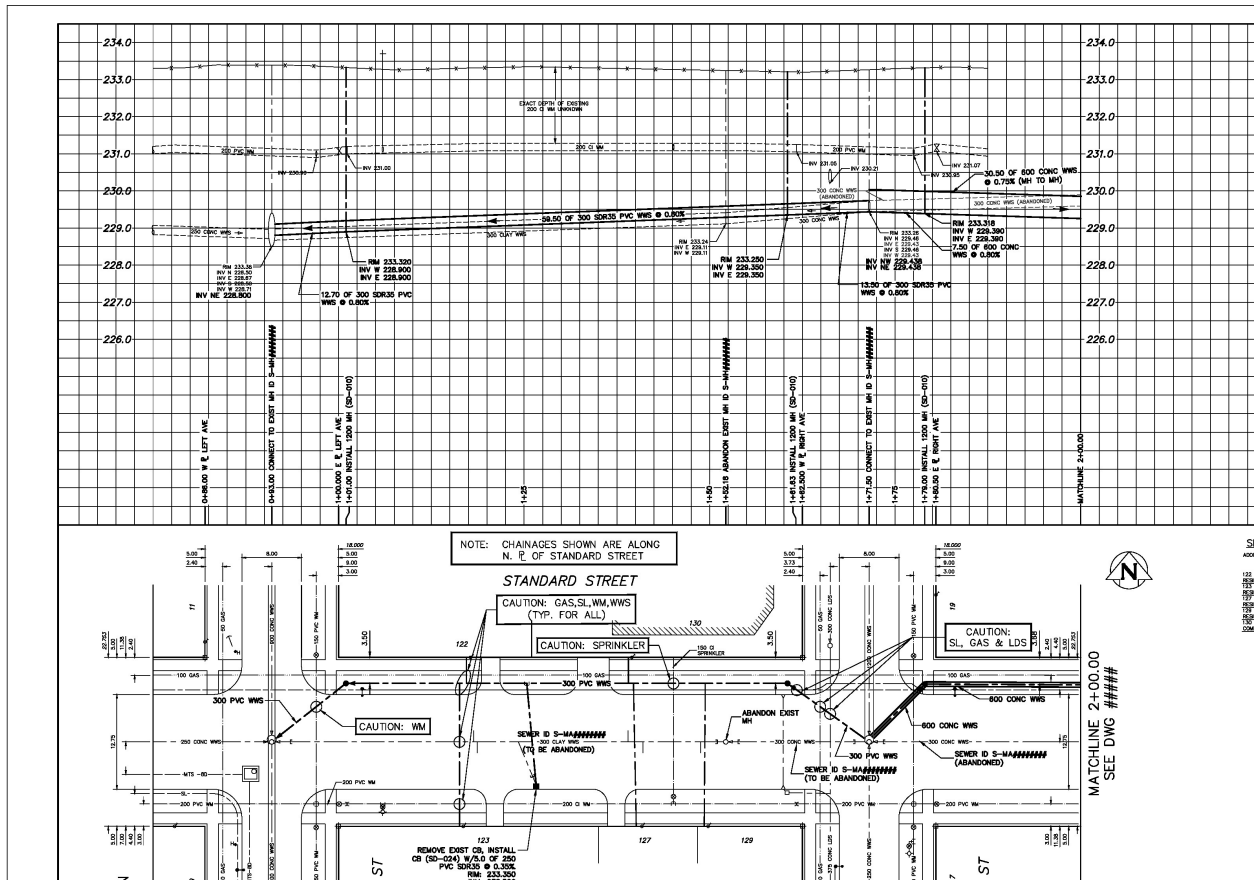

Figure 6
(For a larger view see Appendix G)

3.4.5 Oversize ISO A1 (594 mm x 841 mm) Plan/Profile Sheet – Open Channel (Ditching)

Figure 7 on the following page, is an example of a design for a ditch (Open Channel) re-grading drawn on an A1 size plan/profile sheet. An example of an A1 size Open Channel drawing shall be included with these standards.

Similar to the sewer main renewal example above, the following information shall be shown in the plan portion of the drawing:

- Where applicable, all existing utilities and appurtenances (e.g. manholes, chambers, valves), including water and sewer that fall within the street right-of-way
- All property information such as property lines for the street right-of-way's, street names, lot lines, addresses (or lot, block and plan numbers), and survey monuments and bars.
- All topographic information that falls within a street right-of-way, such as street curb, poles, trees, and sidewalks
- Dimensions (off-set to property lines), for all existing utilities and street rights-of-way
- All proposed design (in bold), including proposed appurtenances, direction of drainage, off-set dimensions to property line, and construction notes specific to the drawing.
- Note: General construction notes shall be shown on the Legend/Drawing Index sheet.
- Separate cross section profile(s) wherever there is a change in the cross section (change in side slope or bottom width)
- A north arrow, scale bar, a note describing the chainage applicable to the drawing, metric note, index reference note, and suitable cautionary and warning notes shall be shown.
- The drawing shall be stamped with the seal of a professional engineer. The seal shall be signed and dated.
- Match lines with stationing shown to two decimal places
- Continuation notes
- Materials list

The following information shall be shown in the profile portion of the drawing:

- All existing water and sewer mains, including size and material
- Existing rim and invert elevations for existing sewer manholes
- Chainage locations shall be noted for all existing and proposed sewer manholes and proposed culverts
- All proposed elevations shall be to three decimal places
- Complete proposed pipe design including, proposed size and material as well as proposed inverts

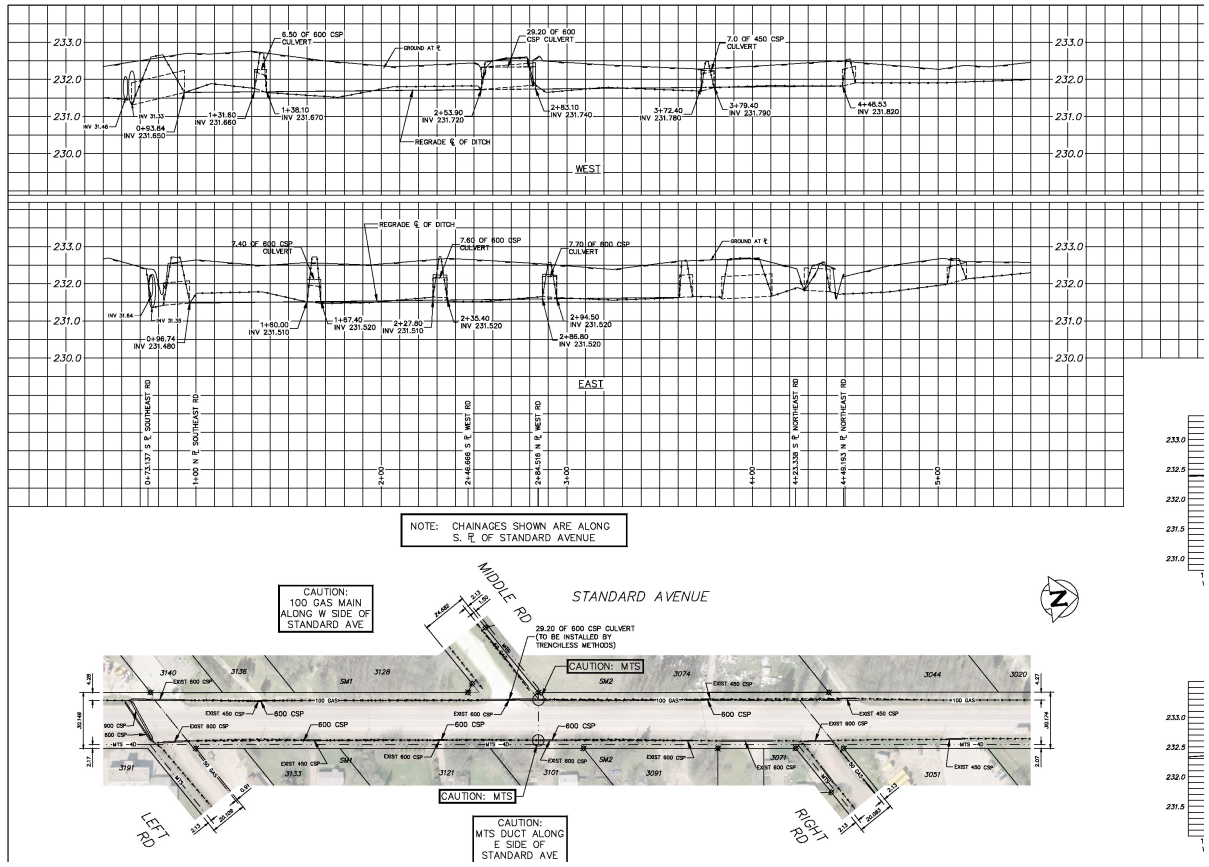

Figure 7
(For a larger view see Appendix H)

11" x 17" Sewer Sheet

As mentioned in Section 3.3 The Prototype Drawing – the 11" x 17" plan drawing sheet shall be used for sewer renewals by CIPP linings, external sewer point repairs (EPR) and trenchless sewer point repairs (TPR).

11" x 17" Sewer Renewal by CIPP Lining

Figure 8 on the following page, is an example of a sewer renewal by CIPP lining utilizing an "11 x 17" drawing sheet. An example of an 11" x 17" size CIPP lining drawing shall be included with these standards.

In general, the following information shall be shown on the drawing:

- Drawn at a 1:750 scale with the current City of Winnipeg air photo. Existing houses and buildings along street rights-of-way visible on-air photo.
- All property information such as property lines for the street right-of-way's, street names, lot lines and addresses (or lot, block and plan numbers).
- All existing water and sewer pipes and appurtenances (e.g. manholes, chambers, valves), that fall within the street right-of-way. Existing Pipe labelled (size, material, and type).
- The portion of the existing main, thickened to show the extent of CIPP lining (Polyline with a Global Width of 0.4). Also labelled with its length, size, sewer ID, and deterioration.
- MH ID, rim and invert elevations for the manholes (up and down stream) on the sewer segments to be lined.
- All existing sewer junctions (sewer service connections at the main), as well as a table showing all sewer junction information as identified by sewer post video inspection records:
 - If a reversal was required indicate with "*****REVERSAL REQUIRED****" on the last row of the table
 - If no service junctions were recorded indicate with "*****NO SERVICE JUNCTIONS****" on the last row of the table
- A north arrow, scale bar, metric note, index reference note, and suitable cautionary and warning notes shall be shown.
- The drawing shall be stamped with the seal of a professional engineer. The seal shall be signed and dated.

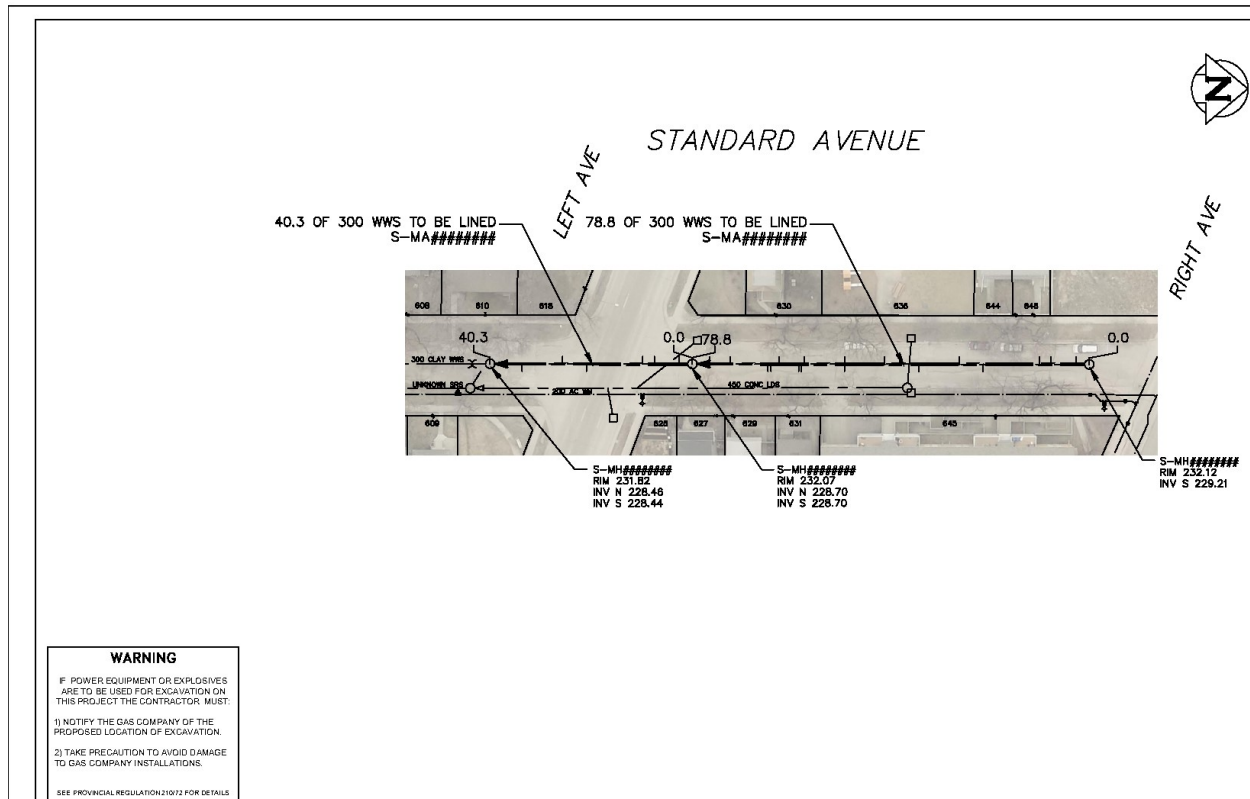

Figure 8
 (For a larger view see Appendix I)

11" x 17" External Point Repair (EPR), Trenchless Point Repair (TPR), Augmentation and Stabilization Sheets

Figure 9 on the following page, is an example of a sewer renewal by EPR displayed on an "11 x 17" drawing sheet. Figure 10 on page 3-19 is an example of a sewer renewal by Augmentation on an "11x17 drawing sheet. An example of an 11" x 17" size EPR drawing shall be included with these standards.

The same example is relevant for a TPR, and augmentation drawing. In general, the following information shall be shown on the drawing:

- All existing utilities and appurtenances (e.g. manholes, chambers, valves), including water and sewer that fall within the street right-of-way.
- All existing sewer junctions (sewer service connections at the main), as well as a table showing all sewer junction information as identified by post sewer post video inspection records.
 - If a reversal was required indicate with "***REVERSAL REQUIRED***" on the last row of the table.
 - If no service junctions were recorded indicate with "***NO SERVICE JUNCTIONS***" on the last row of the table.
- Note all couplings used on the drawing use the coupling block. In addition, note what type of coupling and on which end it is installed.
- Dimensions (off-set from property lines) for all existing utilities and street rights-of-way.

- The portion of the existing main, high-lighted to show the location of the repair. A description of the proposed repair should be indicated and pointed to the high-lighted area (Polyline with a Global Width of 1.0).
- Notes at the upstream and downstream manholes indicating what manhole is at 0.00, and chainage to the beginning and end of the high-lighted location to represent the limits of the EPR.
- Notes on the sewer main in repair indicating the length, standard detail number, and any services that may need to be reconnected.
- If a manhole was installed include diameters for the manhole opening, standard detail, and of any connections that may need to be made.
- Notes at both the upstream and downstream sewer manholes indicating GIS ID number, rim and invert elevations.
- If manhole was replaced, Diameter, SD # and new inverts information shall be shown (new invert in Text_Cyan).
- Sewer ID number for the existing sewer with the repair
- A north arrow, scale bar, metric note, index reference note, and suitable cautionary and warning notes shall be shown.
- The drawing shall be stamped with the seal of a professional engineer. The seal shall be signed and dated.

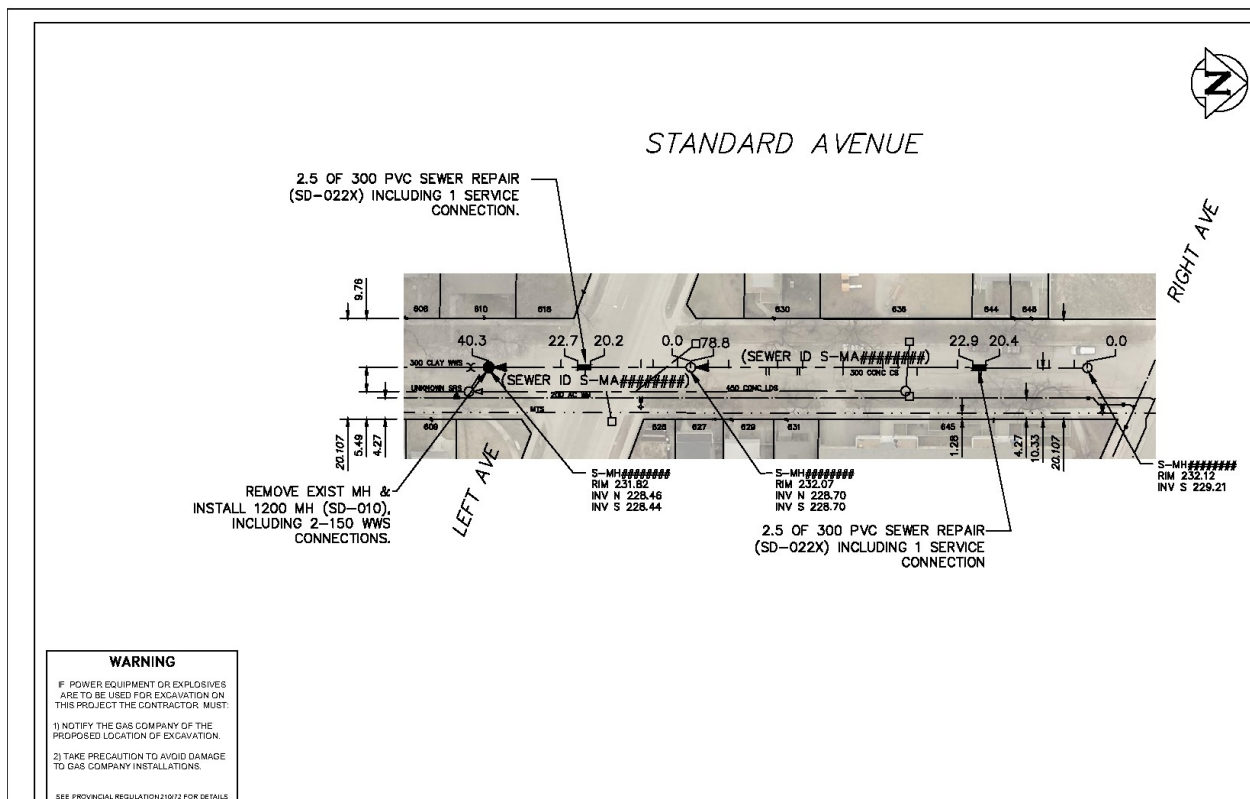

Figure 9
(For a larger view see Appendix J)

11" x 17" Augmented Lining Design Drawing

Figure 10 below is an example of a sewer renewal by Augmented Lining displayed on an "11 x 17" drawing sheet.

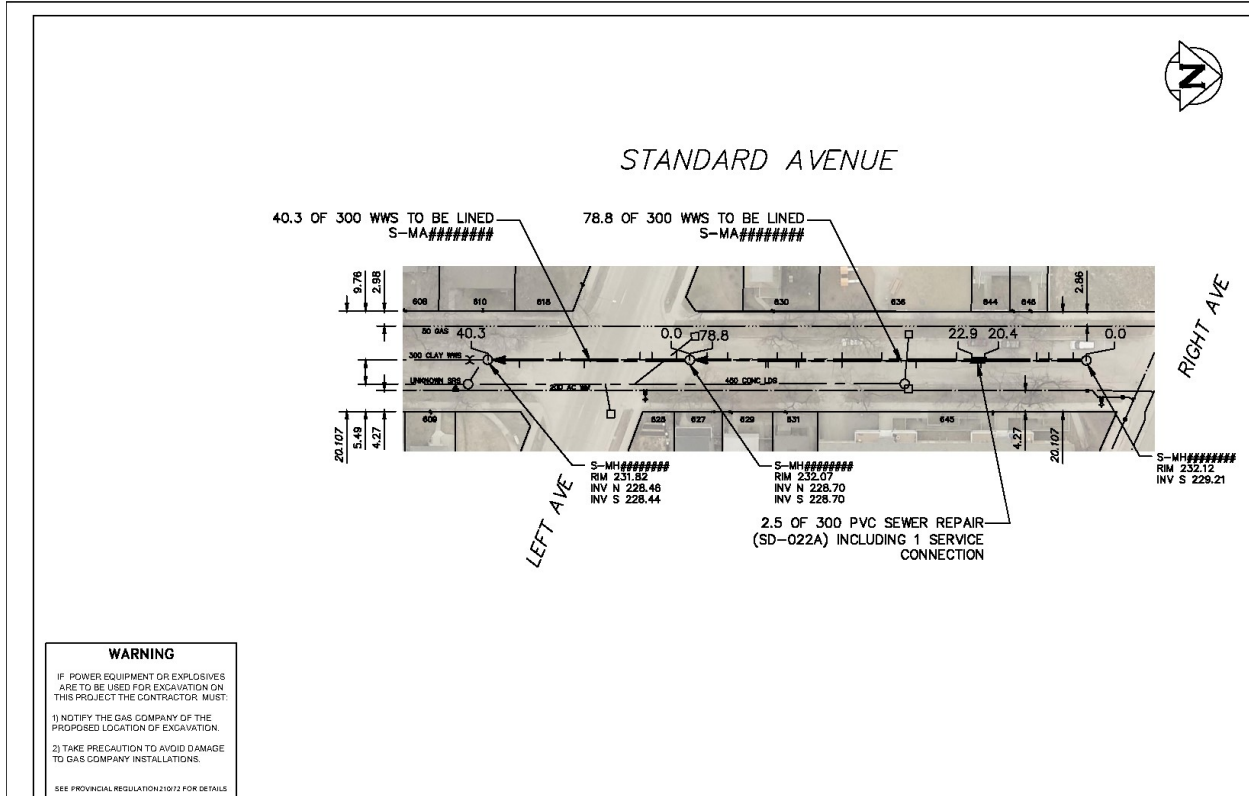

Figure 10
(For a larger view see Appendix K)

3.4.6 Detail Sheets

Detail plan sheets, both A1 and 11" x 17" sizes, shall be used for pumping station upgrade projects and control structure or gate chamber upgrades in order to display plan views, elevation views, complicated details and blow-ups, as well as modified standard drawings such as for manholes.

Oversize ISO A1 (594 mm x 841 mm) Detail Sheet

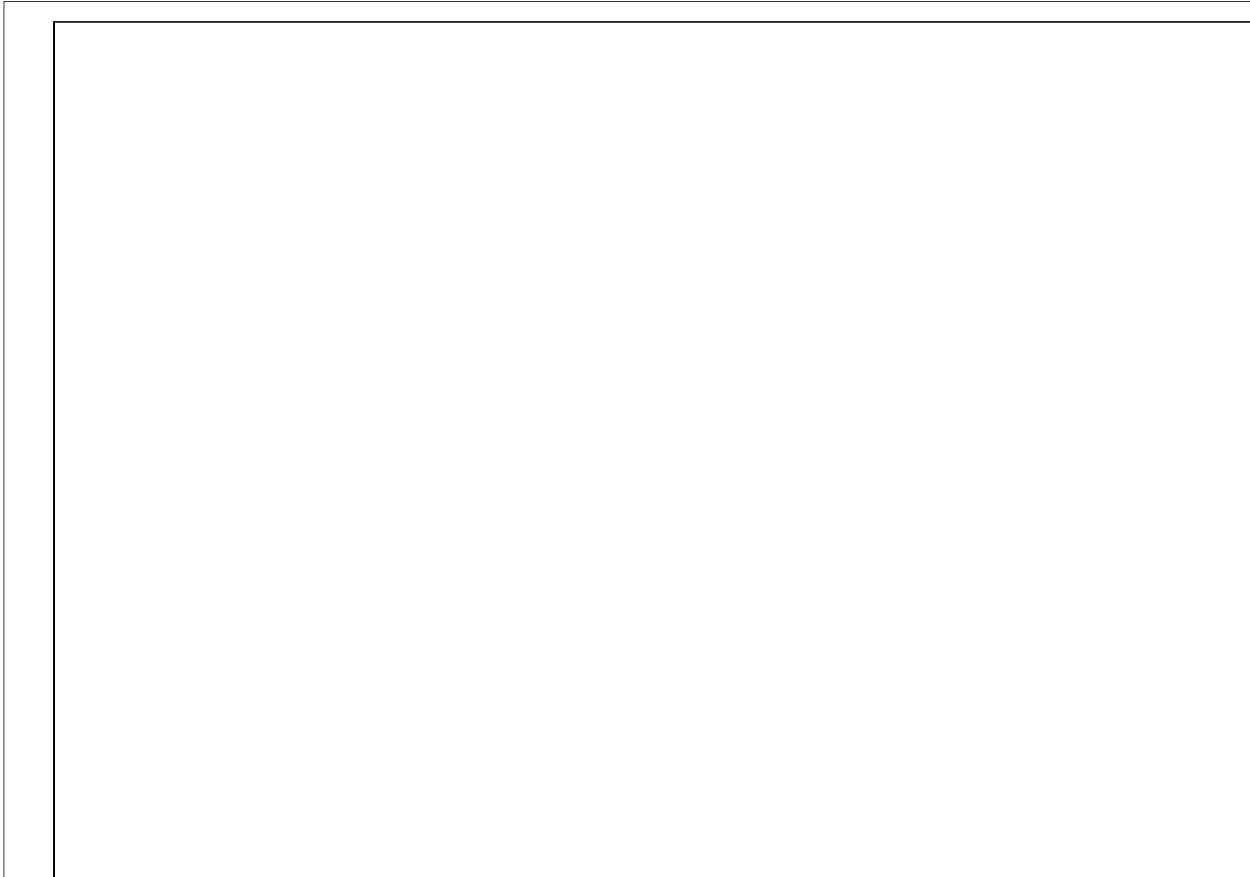

Figure 11
(For a larger view see Appendix L)

11"x 17" Detail Sheet

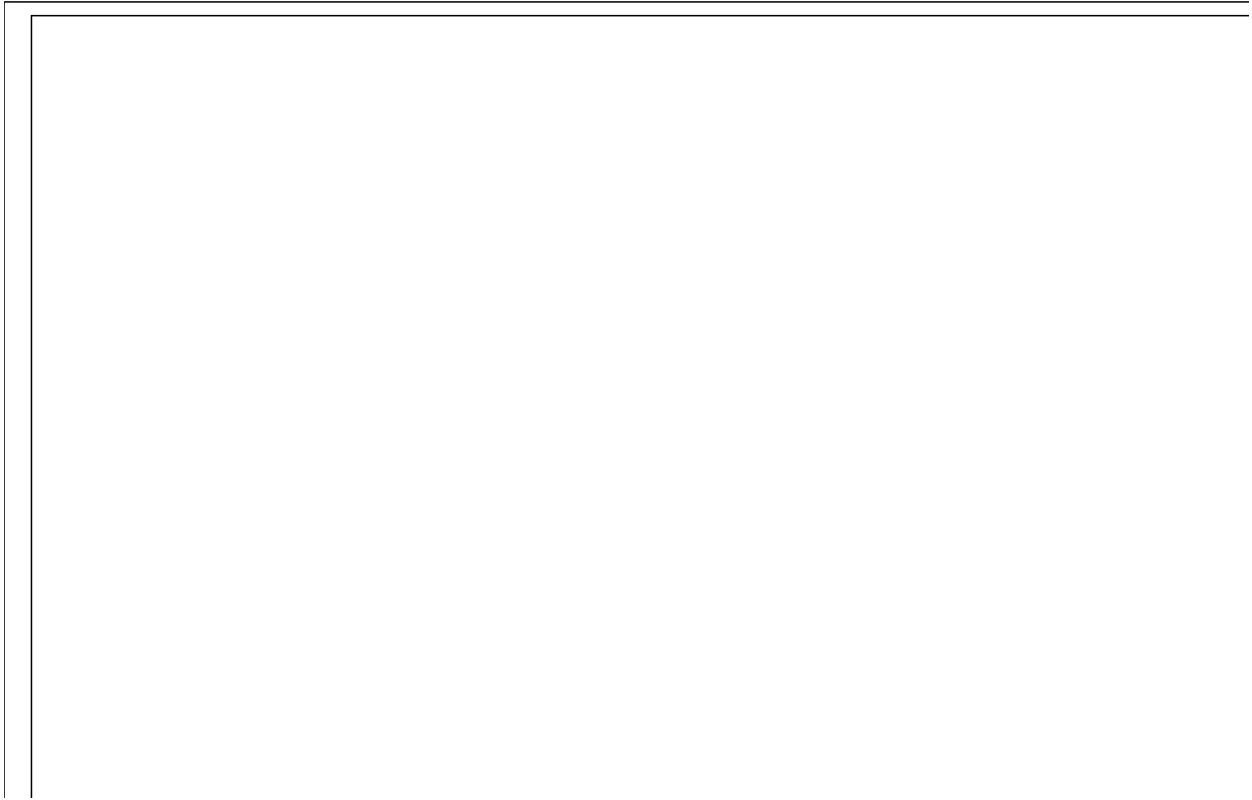

Figure 12
(For a larger view see Appendix M)

3.5 Title Block

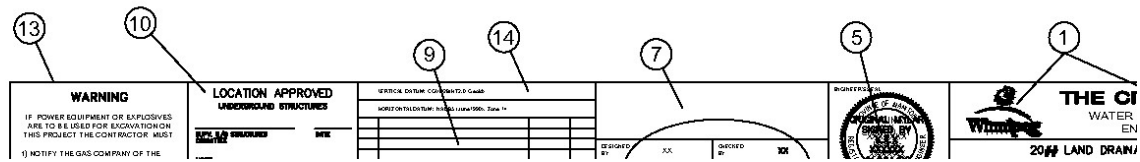

Figure 13

(For a larger view see Appendix N)

1. **City of Winnipeg/Water and Waste Department identification** – space is provided for the City of Winnipeg and WWD logos which shall be provided in the prototype drawing.
2. **Drawing Title Area** – this space shall consist of three parts: Description of the municipal work being installed, the street, and the specific location on that street.
3. **Water and Waste Drawing Number** – shall be supplied prior to the construction and drawing submission upon request, by the Water and Waste Department.
4. **Sheet Identification** – identifies the sheet number and the total number of sheets in the set, e.g. 3 of 12.
5. **Engineer's Seal** – space is provided for the Seal of the Engineer who is responsible for the design. Additional seals shall be placed outside of the title block.
6. **Consultant Drawing Number** – drawings originating from a consulting firm may have a drawing number from their own filing system.
7. **Consultant's Identification** – space is provided for the consultant's name and logo. In the case of an "in-house" project, the Department, Division, Section, or Branch shall be identified in this space, e.g.:

**Public Works Department
Streets Engineering Division**

8. Drawing Details:

- **Designed By:** Initials of designing engineer or technologist
- **Drawn By:** Initials of drafting technician or technologist
- **Checked By:** Understood to mean the drafting and design have been checked by the undersigned
- **Scale:** Horizontal and vertical scale shall be noted here. Detail scale shall be noted on each detail as needed
- **Date:** Date that the drawing was completed
- **Approved By:** Understood to mean approval of the design by the engineer in charge of the project at the consulting firm or at the City of Winnipeg
- **Released for Construction:** The date and signature of the appropriate City official from the Initiating area

9. Revision Section – revision block shall include the number of the revision, brief description of the revision, date revision was completed and the initials of the Engineer (or his designate), that originally approved the drawing.

10. Underground Structures – approval and waiver shall be included in the Title Block of the plan-profile sheet as per the Underground Committee Agreement January 1, 1974. Note that:

Locations of underground structures as shown are based on the best information available, but no guarantee is given that all existing utilities are shown or that the given locations are exact. Confirmation of existence and exact location of all services must be obtained from the individual utilities before proceeding with construction.

11. File Path – space is provided to indicate the location of the digital file of the drawing.

12. Plot Date – space is provided to indicate the date the drawing was printed to hardcopy.

13. Warning note – a note that prohibits some equipment use in designated areas (this note shall not be displayed on Record/As-built drawings).

14. Datum Identification – space provided to display the vertical and horizontal datum's used.

15. Bid Opportunity – space provided to indicate the Bid Opportunity and contract number.

3.6 GENERAL DRAFTING REQUIREMENTS

All drawings shall be metric. Drawing scales, including bar scales and dimensions shall be shown on all drawings. It is not necessary to place the appropriate metric symbol (m or mm) after each dimension if the note, as shown in figure 14 below, is placed boldly on the drawing.

METRIC
WHOLE NUMBERS INDICATE MILLIMETRES
DECIMALIZED NUMBERS INDICATE METRES

Figure 14

Drawings shall be neat and legible with adequate clearance margins between the drawing information and the title block border. Notes and text shall locate and describe the proposed work in sufficient detail to facilitate construction. Limits of construction and match lines shall be clearly marked on the drawing.

All elevations shown on drawings shall be metric geodetic datum. The source and location of the datum shall be clearly noted on each drawing.

The information contained in the drawings shall be oriented in the same datum as the GIS, NAD 1983 June 1990.

Standard details such as manholes, catch basins, hydrants, etc., that are shown and described in the City of Winnipeg Standard Construction Manual do not need not be shown in detail on the drawings. The standard detail drawing number shall be quoted on the plan for reference.

All drawings shall bear the dated stamp/seal and signature of the professional engineer responsible for the design.

Provision shall be made on all drawings for the insertion of the City of Winnipeg - Water & Waste Department drawing number in the space provided in the title block labelled "City Drawing Number". The WWD shall provide the drawing number. Consultant drawing numbers shall be placed in the space in the title block labelled for that purpose.

Existing Numerical values shown on the Construction drawings shall be to two (2) decimal places, three (3) decimal places are to be used to anything that was installed as part of the project or unless accuracy warrants otherwise.

Main line water valves installed in the City of Winnipeg turn either to the left, (counter-clockwise) or to the right (clockwise) to close, depending on the area they are being located in, (see Figure 15, on the following page).

Actual proposed works such as sewer mains, water mains, or valves in the plan portion of the drawing shall be created in the model space tab. Other components of the drawing submittal such as design notes, text, dimensions, etc. should be drawn in paper space.

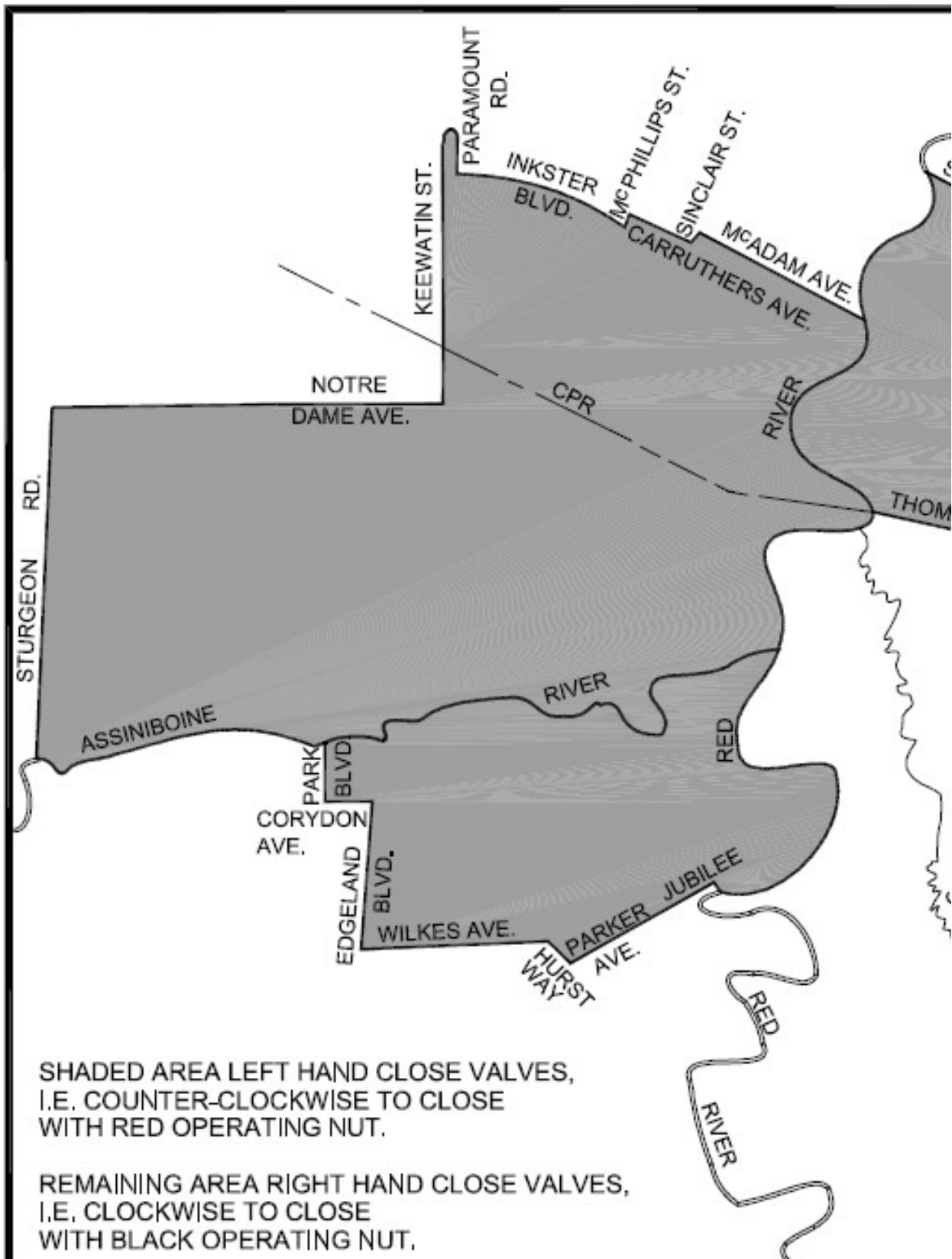

Figure 15

A note (whichever is applicable), similar to the example shown below in figure 16 shall be shown on all drawings.

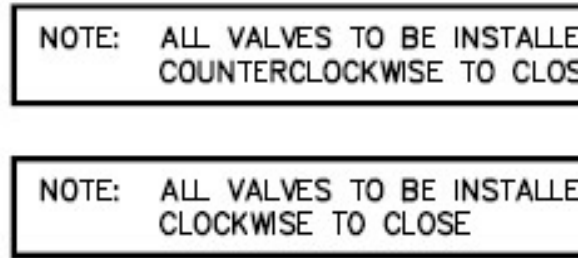

Figure 16

Whenever the proposed location for the new water or sewer infrastructure is in close proximity to a gas line a caution note shall be placed in the plan portion of the drawing as close to the potential conflict as possible. The cautionary note should look similar to Figure 17 below.

WARNING

IF POWER EQUIPMENT OR EXPLC
ARE TO BE USED FOR EXCAVATIC
THIS PROJECT THE CONTRACTOR

1) NOTIFY THE GAS COMPANY OF T
PROPOSED LOCATION OF EXCAVA

2) TAKE PRECAUTION TO AVOID DA
TO GAS COMPANY INSTALLATIONS

Figure 17

3.6.1 Drawing Orientation

Plans shall be oriented to allow the pointing of the north arrow to the top or to the right of the sheet for the major portion of the alignment. Assuming the top of the sheet as due north, the range within which the north arrow may point is from 45° west of north to 135° east of north (see Figure 18 below).

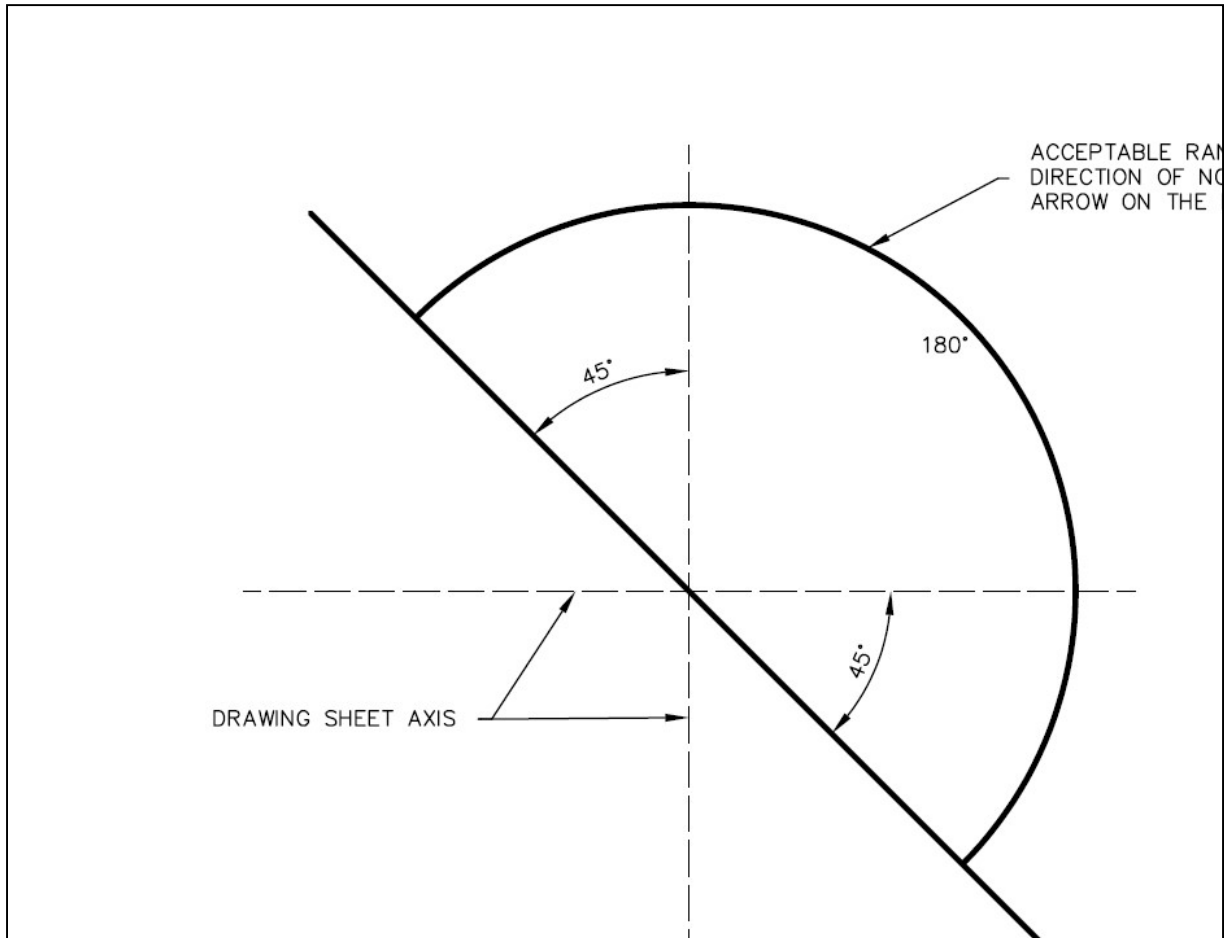

Figure 18

3.6.2 Text Orientation

The direction of lettering shall conform to the slope of the symbol or line. The correct placement is as shown in Figure 19 below. The space between line and lettering shall not be less than 1mm.

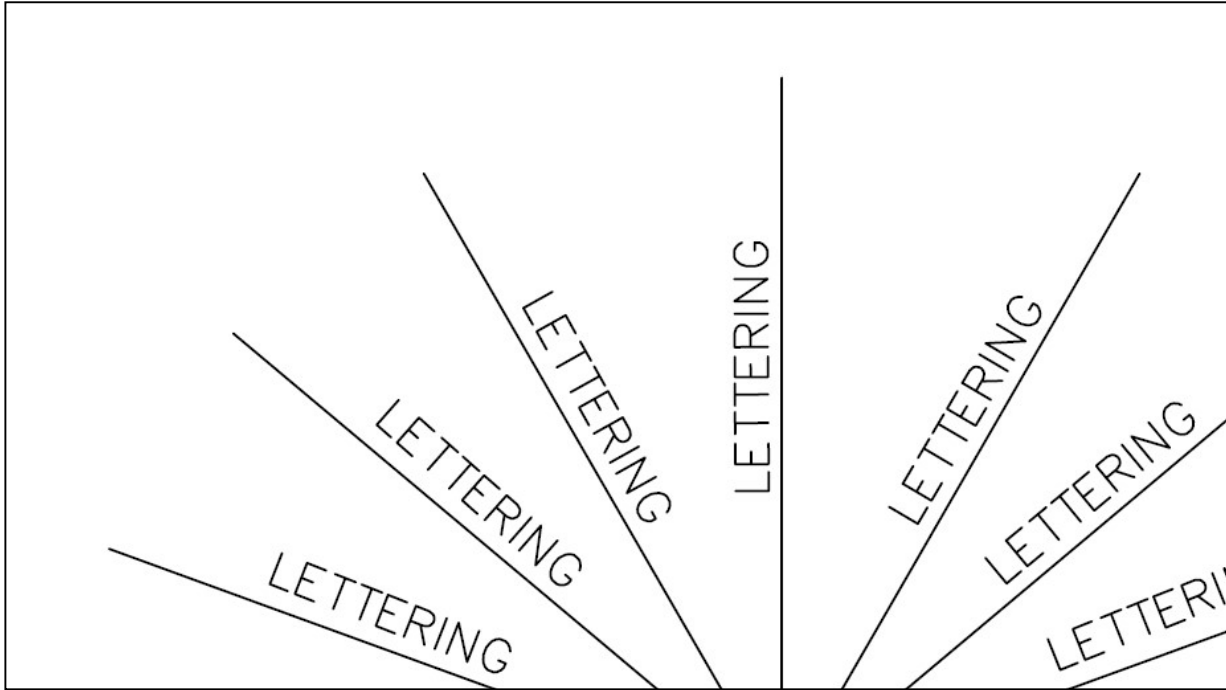

Figure 19

3.6.3 Caution Note for Other Utilities

A utility caution note, similar to the examples in Figure 20 below, shall be placed in close proximity or connected with a leader line to the applicable area, on all drawings.

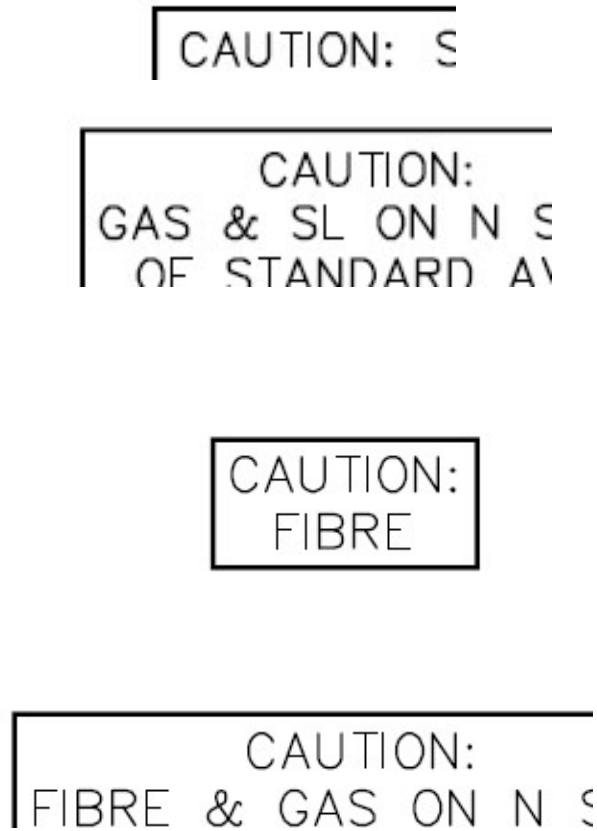

Figure 20

3.6.4 Legend

A Legend shall be included as part of the legend/drawing index sheet:















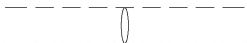
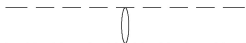

DESCRIPTION	PROFILE	
	ABANDONED	EXISTING
WATER PIPE		
HYDRANT TOP		
VALVE		
TEE OR CROSS		
COUPLING OR BEND		
REDUCER		
END OF PIPE		
SEWER PIPE		
UNPAVED GROUND SURFACE		
PAVED GROUND SURFACE – ϕ PIPE		
GUTTER (NORTH AND WEST)		
GUTTER (SOUTH AND EAST)		
ϕ DITCH (NORTH AND WEST)		
ϕ DITCH (SOUTH AND EAST)		

Figure 21
(For a larger view see Appendix 0)

LEGEND

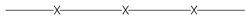
DESCRIPTION	PLAN VIEW		
	ABANDONED	EXISTING	PI
WATER PIPE	---	---	---
FIRE HYDRANT		⊙	
VALVE	⊗	⊗	
CURB STOP	♂	♂	
REDUCER	◁	◁	
COUPLING OR SLIDDER		X	
CROSS	⊕	⊕	
BEND - 11.25°, 22.5°, 45°, 90°	┌┐┐┐	┌┐┐┐	┌┐┐┐
TEE	⊕	⊕	
VERTICAL BEND	H	H	
ANODE		⤿	
REPAIR MARKER		Ⓜ	
PLUG	J	J	
SEWER PIPE	---	---	---
MANHOLE	○	○	
CATCH BASIN	□	□	
CURB INLET	▽	▽	
JUNCTION	┌┐┐┐	┌┐┐┐	┌┐┐┐
☑ DITCH		→	→
CULVERT		⌈⌋	⌈⌋
SURVEY BAR		⊕	
SURVEY MONUMENT		⊙	
TREE - DECIDUOUS		⊙	
TREE - CONIFEROUS		⊙	
HYDRO		---	---
HYDRO POLE		•H	
LAMP STANDARD		•	
HYDRO POLE W/STREET LIGHTING		•H	
POLE		•	
GUY ANCHOR		└	
M.T.S. POLE		•M	
PEDESTAL OR BOX		⊗	
CABINET		⊗	
M.T.S., SHAW, OR VIDEON		---	---
TRAFFIC SIGNALS		---	---
TRAFFIC LIGHT STANDARD		•→	
GAS		---	---
STEAM		---	---
FIBRE OPTIC		---	---
FENCE		x	x
EDGE OF PAVEMENT OR GUTTER		---	---

Figure 22
(For a larger view see Appendix 0)

3.6.5 Drawing Scales

All drafting shall be done at 1:1, in decimal units, and in the AutoCAD model space environment. Plotting shall be done using the plot layout tools of AutoCAD's paper space environment. Drawing sheets shall be set up at a scale of 1:1 and views in the drawing shall be scaled using viewport scaling. In addition to the drawing border, other entities to be placed in paper space include general notes, north arrows and bar scale. All profiles are to be drawn in paper space.

The standard scale for a water main renewal project is 1:250 horizontal and 1:50 vertical.

The standard scale for a full segment sewer renewal project is 1:250 horizontal and 1:50 vertical.

The standard scale for large land drainage/ditch projects is 1:1000 horizontal and 1:50 vertical.

The standard scale for external point repairs, trenchless point repairs and sewer renewals by CIPP linings is 1:750 horizontal, and no profile is required.

The standard line type scale for all drawing lines is 1. Each drawing line type scale or 'LT scale' shall be set to 10 and Paper Space scale or 'paper scale LT scale' shall be set to 1.

4.0 Layers Required in the Final GIS Drawing

Layers, layer names, and layer properties are pre-set as part of the WWD supplied prototype drawings. AutoCAD to GIS or 'AG' block names shall be used for the proposed works.

If, when preparing the **Final GIS Drawing**, there is a project for which there are no layer names available, the consultant shall notify the Department and a layer name and specifics shall be provided. Once implemented by the Department, these layers shall become part of the prototype drawing.

To facilitate exchange with the Departments GIS, layers and symbols in the Final GIS Drawing shall not be edited and are used 'as is.' No layer names, other than those in the City's layer name list, shall be present in this drawing file. There are exceptions for those layer names automatically created by AutoCAD, (e.g., 0, DEFPOINTS, and ASHADE).

With the exception of survey point layers, layer names created by third party software or add-ons, including Autodesk add-ons shall not be accepted in the Final GIS Drawing.

(For a complete list of all the WWD layers see pages 4-1 to 4-5)

4.1.1 Sewer

Only these layers, whichever are applicable, shall be used in the Final GIS drawing for sewer renewals, sewer renewal by CIPP lining/augmented lining, combined sewer relief (SRS), force mains, external point repairs, trenchless point repairs, gate chambers, interceptor sewers, land drainage sewers, open channel (ditching), or outfall repairs.

WWD REQUIRED LAYERS - FINAL GIS DRAWING (SEWER)

NAME	LINETYPE	FEATURE TYPE	PLOT STYLE	PLOTTABLE	DESCRIPTION
AG_BLOCK_ENTITIES	CONTINUOUS	LINEAR	COLOR_3 (GREEN)	YES	USED FOR ALL ENTITIES WITHIN A BLOCK REPRESENTING A PROPOSED OBJECT
AG_BLOCK_ENTITIES_E	CONTINUOUS	LINEAR	COLOR_1 (RED)	YES	USED FOR ALL ENTITIES WITHIN A BLOCK REPRESENTING AN EXISTING OBJECT
AG_OC_CHANNEL_JUNCTION	CONTINUOUS	POINT	COLOR_7 (WHITE)	YES	USED AT CHANGES OF PROPOSED DITCH GRADE AND/OR ALIGNMENT. ALSO AT BEGINNING & END OF A DITCH
AG_OC_CHANNEL_LINE	DITCHLINE	LINEAR	COLOR_7 (WHITE)	YES	USED AT THE CENTERLINE OF A PROPOSED DITCH OR CULVERT
AG_OC_INLET_OUTLET	CONTINUOUS	POINT	COLOR_7 (WHITE)	YES	USED AT THE TERMINATION OF CULVERT ENDS
AG_OC_INLET_OUTLET_CB	CONTINUOUS	BLOCK	COLOR_3 (GREEN)	YES	USED FOR PROPOSED CB'S WHICH DRAIN DITCHES INTO A CLOSED SYSTEM
AG_OC_INLET_OUTLET_E_CB	CONTINUOUS	BLOCK	COLOR_1 (RED)	YES	USED FOR EXISTING CB'S WHICH DRAIN A DITCH INTO A CLOSED SYSTEM
AG_OC_INLET_OUTLET_E_MH	CONTINUOUS	BLOCK	COLOR_1 (RED)	YES	USED FOR PROPOSED MH'S WHICH DRAIN DITCHES INTO A CLOSED SYSTEM
AG_OC_INLET_OUTLET_MH	CONTINUOUS	BLOCK	COLOR_3 (GREEN)	YES	USED FOR EXISTING MH'S WHICH DRAIN A DITCH INTO A CLOSED SYSTEM
AG_OC_XSECTION_POINT	CONTINUOUS	POINT	COLOR_7 (WHITE)	YES	USED FOR POINTS PROVIDING NORTHING, EASTING, AND ELEVATION ALONG A X-SECTION.
AG_SEWER_BEND	CONTINUOUS	BLOCK	COLOR_3 (GREEN)	YES	USED AT PROPOSED SEWER BENDS
AG_SEWER_CB	CONTINUOUS	BLOCK	COLOR_3 (GREEN)	YES	USED AT PROPOSED CB'S (NOT DRAINING DITCHES)
AG_SEWER_CB_LEAD	CENTER	LINEAR	COLOR_5 (BLUE)	YES	USED FOR CB LEADS (PIPE BETWEEN CB AND CONNECTION TO SEWER)
AG_SEWER_CB_TEE	CONTINUOUS	BLOCK	COLOR_3 (GREEN)	YES	USED FOR PROPOSED CB TEE'S (CONNECTION AT SEWER END OF CB LEAD)
AG_SEWER_CHAMBER	CONTINUOUS	LINEAR	COLOR_5 (BLUE)	YES	USED FOR SEWER CHAMBER OUTLINES
AG_SEWER_CI	CONTINUOUS	BLOCK	COLOR_3 (GREEN)	YES	USED FOR PROPOSED CURB INLETS (CI)
AG_SEWER_CONNECTION	CONTINUOUS	POINT	COLOR_7 (WHITE)	YES	USED WHERE A SEWER SERVICE CONNECTS WITH A SEWER
AG_SEWER_COUPLER	CONTINUOUS	BLOCK	COLOR_3 (GREEN)	YES	USED FOR SEWER COUPLINGS
AG_SEWER_END	CONTINUOUS	POINT	COLOR_7 (WHITE)	YES	USED AT THE END OF A SEWER PIPE (END OF OUTFALL PIPE, ETC.)
AG_SEWER_EPR	CENTER	LINEAR	COLOR_6 (MAGENTA)	YES	USED FOR EXTERNAL POINT REPAIRS
AG_SEWER_EXIST_CB	CONTINUOUS	BLOCK	COLOR_1 (RED)	YES	USED ON AN EXISTING CB WHICH A PROPOSED PIPE IS TO BE CONNECTED
AG_SEWER_EXIST_CI	CONTINUOUS	BLOCK	COLOR_1 (RED)	YES	USED ON AN EXISTING CI WHICH A PROPOSED PIPE IS TO BE CONNECTED
AG_SEWER_GATEVALVE	CONTINUOUS	BLOCK	COLOR_3 (GREEN)	YES	USED FOR PROPOSED GATE VALVES (SLUICE, GATES)
AG_SEWER_EXIST_MANHOLE	CONTINUOUS	BLOCK	COLOR_1 (RED)	YES	USED ON AN EXISTING MH WHICH A PROPOSED PIPE IS TO BE CONNECTED

Figure 23

AG_SEWER_YARD_DRAIN_INLET	CONTINUOUS	BLOCK	COLOR_3 (GREEN)	YES	USED FOR PROPOSED YARD DRAIN INLETS
EASEMENTS	DASHED	GREEN	COLOR_3	YES	USED FOR INDICATING EASEMENTS
E_SEWER_ABAND_PLAN	CENTER	DARK GREY	COLOR_8	YES	USED FOR ALL ABANDONED SEWER PIPES & BLOCKS IN PLAN
E_SEWER_PLAN	CENTER	RED	COLOR_1	YES	USED FOR ALL EXISTING SEWER PIPES & BLOCKS IN PLAN
E_SEWER_SERVICES_PLAN	CENTER	RED	COLOR_1	YES	USED FOR EXISTING SEWER SERVICES IN PLAN
LEGAL	CONTINUOUS	LINEAR	COLOR_4 (CYAN)	YES	USED FOR ALL LEGAL LINES BESIDES LOT LINES
LOT LINES	CONTINUOUS	LINEAR	COLOR_3 (GREEN)	YES	USED FOR LOT LINES
TEXT_ADDRESS	-	TEXT	COLOR_3 (GREEN)	YES	USED FOR PROPERTY ADDRESS
ZPTSEWER	-	POINT	COLOR_7 (WHITE)	YES	FOR ALL SEWER RELATED SURVEY

Figure 23 (Continued)

4.1.2 Water

Only these layers, whichever are applicable, shall be used in the Final GIS drawing for water main renewals, feeder mains, aqueduct, and valve chambers:

WWD REQUIRED LAYERS - FINAL GIS DRAWING (WATER)

NAME	LINETYPE	FEATURE TYPE	PLOT STYLE	PLOTTABLE	DESCRIPTION
AG_AQ_JOINT_LOCATION	CONTINUOUS	POINT	COLOR_7 (WHITE)	YES	USED AT JOINT LOCATIONS ON AN AQUEDUCT
AG_AQ_PRESS_MANHOLE	CONTINUOUS	BLOCK	COLOR_7 (WHITE)	YES	USED AT PRESSURE MANHOLES ON AN AQUEDUCT
AG_AQ_UNDERDRAIN_PIPE	CONTINUOUS	LINEAR	COLOR_7 (WHITE)	YES	USED FOR UNDERDRAIN PIPE ALONG AN AQUEDUCT
AG_CATHODIC PROTECTION_MONITORING_SYSTEM	CONTINUOUS	BLOCK	COLOR_3 (GREEN)	YES	USED FOR LOCATIONS OF CATHODIC PROTECTION MONITORING SYSTEMS
AG_BLOCK_ENTITIES_E	CONTINUOUS	LINEAR	COLOR_3 (RED)	YES	USED FOR ALL ENTITIES WITHIN A BLOCK REPRESENTING A EXISTING OBJECT
AG_BLOCK_ENTITIES	CONTINUOUS	LINEAR	COLOR_3 (GREEN)	YES	USED FOR ALL ENTITIES WITHIN A BLOCK REPRESENTING A PROPOSED OBJECT
AG_WATER_ANODE	CONTINUOUS	BLOCK	COLOR_3 (GREEN)	YES	USED FOR PROPOSED ANODES ON WATERMAINS
AG_WATER_BEND	CONTINUOUS	BLOCK	COLOR_3 (GREEN)	YES	USED FOR PROPOSED SEWER BENDS
AG_WATER_BLOW_OFF_VALVE	CONTINUOUS	BLOCK	COLOR_3 (GREEN)	YES	USED FOR PROPOSED BLOW OFF VALVES
AG_WATER_CASEMENT	CENTER	LINEAR	COLOR_4 (CYAN)	YES	USED FOR PROPOSED CASEMENT PIPE
AG_WATER_CATHODIC PROTECTION	CONTINUOUS	LINEAR	COLOR_5 (BLUE)	YES	USED FOR A LENGTH OF EXISTING WATERMAIN WHICH IS TO BE CATHODICALLY PROTECTED
AG_WATER_CONNECT	CONTINUOUS	POINT	COLOR_7 (WHITE)	YES	USED AT PROPOSED CONNECTIONS TO EXISTING WATERMAINS WITHOUT COUPLING (BELL TO SPIGOT, ETC.)
AG_WATER_CONNECTION	CONTINUOUS	POINT	COLOR_7 (WHITE)	YES	USED AT PROPOSED WATER SERVICE CONNECTIONS AT A WATERMAIN (CORPORATION STOP)
AG_WATER_COUPLER	CONTINUOUS	BLOCK	COLOR_3 (GREEN)	YES	USED FOR PROPOSED COUPLINGS
AG_WATER_CROSS	CONTINUOUS	BLOCK	COLOR_3 (GREEN)	YES	USED FOR PROPOSED CROSSES
AG_WATER_CURB_STOP	CONTINUOUS	BLOCK	COLOR_3 (GREEN)	YES	USED FOR PROPOSED CURB STOPS
AG_WATER_DRAIN_VALVE	CONTINUOUS	BLOCK	COLOR_3 (GREEN)	YES	USED FOR DRAIN VALVES AT CHAMBERS (VALVE PITS, ETC.)
AG_WATER_HYDRANT	CONTINUOUS	BLOCK	COLOR_3 (GREEN)	YES	USED FOR PROPOSED HYDRANTS
AG_WATER_HYDRANT_BRANCH	WATER	LINEAR	COLOR_4 (CYAN)	YES	USED FOR ALL PIPE WITHIN A PROPOSED HYDRANT ASSEMBLY
AG_WATER_HYDRANT_TEE	CONTINUOUS	BLOCK	COLOR_3 (GREEN)	YES	USED FOR THE TEE OF A PROPOSED HYDRANT ASSEMBLY
AG_WATER_HYDRANT_VALVE	CONTINUOUS	BLOCK	COLOR_3 (GREEN)	YES	USED FOR THE VALVE ON A PROPOSED HYDRANT ASSEMBLY
AG_WATER_MAIN	WATER	LINEAR	COLOR_5 (BLUE)	YES	USED FOR PROPOSED WATERMAINS
AG_WATER_PLUG	CONTINUOUS	BLOCK	COLOR_3 (GREEN)	YES	USED FOR PROPOSED WATERMAIN PLUGS
AG_WATER_REDUCER	CONTINUOUS	BLOCK	COLOR_3 (GREEN)	YES	USED FOR PROPOSED WATERMAIN REDUCERS
AG_WATER_RELEASE_AIRVALVE	CENTER	BLOCK	COLOR_3 (GREEN)	YES	USED FOR PROPOSED AIR RELEASE VALVES
AG_WATER_SERVICE_CONNECTION	CONTINUOUS	POINT	COLOR_7 (WHITE)	YES	USED AT THE LOCATION WHERE A PROPOSED WATER SERVICE PIPE CONNECTS TO AN EXISTING SERVICE PIPE (RECONNECTION)
AG_WATER_SERVICE_PIPE	WATER	LINEAR	COLOR_4 (CYAN)	YES	USED FOR PROPOSED WATER SERVICE PIPES
AG_WATER_SERVICE_Y	CONTINUOUS	BLOCK	COLOR_3 (GREEN)	YES	USED FOR PROPOSED Y'S ON A PROPOSED WATER SERVICE
AG_WATER_TEE	CONTINUOUS	BLOCK	COLOR_3 (GREEN)	YES	USED FOR PROPOSED TEE'S (NOT HYDRANT TEE'S)
AG_WATER_THRUSTBLOCK	CONTINUOUS	BLOCK	COLOR_3 (GREEN)	YES	USED FOR PROPOSED WATERMAIN THRUSTBLOCKS

Figure 24

AG_WATER_VALVE	CONTINUOUS	BLOCK	COLOR_3 (GREEN)	YES	USED FOR PROPOSED WATERMAIN VALVES
AG_WATER_EXIST_VALVE	CONTINUOUS	BLOCK	COLOR_1 (RED)	YES	USED FOR EXISTING VALVES WHICH A PROPOSED PIPE IS TO BE CONNECTED
AG_WATER_VALVE_PIT	CONTINUOUS	LINEAR	COLOR_3 (GREEN)	YES	USED FOR OUTLINE OF PROPOSED VALVE PITS
E_WATER_ABAND_PLAN	WATER	LINEAR	COLOR_8	YES	USED FOR ALL ABANDONED WATER PIPES & BLOCKS IN PLAN
E_WATER_PLAN	WATER	LINEAR	COLOR_1 (RED)	YES	USED FOR ALL EXISTING WATER PIPES & BLOCKS IN PLAN
E_WATER_SERVICES_PLAN	WATER	LINEAR	COLOR_1 (RED)	YES	USED FOR EXISTING WATER SERVICES IN PLAN
EASEMENTS	DASHED	LINEAR	COLOR_3 (GREEN)	YES	USED FOR INDICATING EASEMENTS
LEGAL	CONTINUOUS	LINEAR	COLOR_4 (CYAN)	YES	USED FOR ALL LEGAL LINES BESIDES LOTLINES
LOTLINES	CONTINUOUS	LINEAR	COLOR_3 (GREEN)	YES	USED FOR LOTLINES
TEXT_ADDRESS	-	TEXT	COLOR_3 (GREEN)	YES	USED FOR PROPERTY ADDRESSES
ZPTWATER	-	POINT	COLOR_7 (WHITE)	YES	FOR ALL WATER RELATED SURVEY

Figure 24 (Continued)

4.1.3 Blocks and Symbols – General Information

Each symbol used by the WWD for GIS input is a block. Symbols shall be issued for use in the Final GIS Drawing of projects for the WWD. Only these symbols shall be used in these drawings. A DVD or CD containing the Department's symbol file shall be provided along with the standard prototype drawings. These symbols shall be added to the consultant's own symbol library.

Whenever possible, make use of WWD's supplied standard symbols. From time to time these symbols will be revised and/or new symbols will be added. If for any reason there is a need to create a new symbol either for local use or to keep for future projects, a request shall be made to the Department and a symbol shall be created. This symbol shall then become part of the WWD's standard symbol file.

To facilitate the data exchange with the Department's GIS, standard issue symbols for use in the Final GIS Drawing shall not be exploded, renamed or changed in any way.

Objects that are repeated throughout and/or are depicted in an exaggerated scale for clarity (fire hydrants, catch basins, water valves, etc.) shall be represented by a symbol.

North arrows, graphical scales, logos, location maps and other similar symbols shall be inserted as blocks and left unexploded.

Consultants can insert a company logo or identification information in the form of an unexploded block. This block can be placed on all sheets, including the cover sheet, within the drawing area of each sheet.

4.1.4 AutoCAD to GIS Blocks or 'AG' Blocks

Block names beginning with 'AG' are to be used for proposed works in the Final GIS Drawing only. For existing items, the blocks indicated in **Figure 24 of the symbol list** shall be used.

Note that layer names do not begin with 'AG'. The only exception occurs when proposed works are going to be connected to an existing item (e.g. MH's, CB's, Hydrants, Valves, etc.), in which case the appropriate AG block as shown on Figure 25 and 26 shall to be used (e.g., S-E-CB, W-E-VALVE, etc.).

All AG blocks have a point constructed into the block which can be used as the snap point when being inserted. The point in each block has its own layer name which is integral to the AutoCAD to GIS conversion process.

AG blocks such as valves, manholes, catch basins, curb inlets, curb stops, hydrants, and flow direction arrows have wipeout masks built into them so the linear features they are attached to will not need to be trimmed.

The following steps must be followed so drawings with these blocks look correct:

- The drawing units and insertion units should be set to 'unitless'
- Insertion scale for A1 sized drawings should be 250 (x, y, and z scale factors)
- Insertion scale for 11x17 sized drawings should be 750 (x, y, and z scale factors)
- Wipeout frames should be set to 'off'
- All lines passing through a block with wipeouts should be 'sent to back' in the display order - not trimmed
- All block masking/wipeout layers (BLOCK WIPEOUT and BLOCK_MASKING), should be set as 'plot table'

4.1.5 Symbol List

STANDARD BLOCKS			
BLOCK SYMBOL	BLOCK NAME (.dwg)	LAYER NAME	DESCRIPTIC
	E_11 Bend	E_WATER_PLAN or E_SEWER_PLAN	EXISTING 11.25° BENDS FOR SEWER
	E_22 Bend	E_WATER_PLAN or E_SEWER_PLAN	EXISTING 22.5° BENDS FOR SEWER
	E_45 Bend	E_WATER_PLAN or E_SEWER_PLAN	EXISTING 45° BENDS FOR SEWER
	E_90 Bend	E_WATER_PLAN or E_SEWER_PLAN	EXISTING 90° BENDS FOR SEWER
	E_Anode	E_WATER_PLAN	EXISTING ANODES
	E_Catch Basin	E_SEWER_PLAN	EXISTING CATCH BASIN
	E_Coupling	E_WATER_PLAN or E_SEWER_PLAN	EXISTING COUPLINGS FOR SEWER
	E_Cross	E_WATER_PLAN or E_SEWER_PLAN	EXISTING CROSS FOR SEWER AND
	E_Curb Inlet	E_SEWER_PLAN	EXISTING CURB INLET
	E_Curb Stop	E_WATER_PLAN	EXISTING CURB STOPS
	E_Hydrant	E_WATER_PLAN	EXISTING FIRE HYDRANT
	E_Manhole	E_SEWER_PLAN	EXISTING MANHOLES
	E_Plan_Flow_Arrow	E_SEWER_PLAN	EXISTING SEWER FLOW DIRECTION
	E_Plug	E_WATER_PLAN or E_SEWER_PLAN	EXISTING PLUG ON SEWER OR WAT
	E_Profile_Ellipse	E_WATER_PROFILE or E_SEWER_PROFILE	CROSSING SEWER OR WATER PIPE
	E_Profile_Hydrant Top	E_WATER_PROFILE	SECTION OF HYDRANT ABOVE THE
	E_Profile_Pipe End	E_WATER_PROFILE or E_SEWER_PROFILE	PIPE CONTINUATION AT LIMITS OF P
	E_Profile_Valve	E_WATER_PROFILE or E_SEWER_PROFILE	EXISTING VALVES IN PROFILE
	E_Reducer	E_WATER_PLAN or E_SEWER_PLAN	EXISTING REDUCER FOR SEWER AN
	E_Tee	E_WATER_PLAN or E_SEWER_PLAN	EXISTING TEE FOR SEWER AND WAT
	E_Thrust Block	E_WATER_PLAN or E_SEWER_PLAN	EXISTING THRUST BLOCK FOR SEWI
	E_Valve	E_WATER_PLAN or E_SEWER_PLAN	EXISTING VALVE FOR SEWER AND V
	E_Vertical Bend	E_WATER_PLAN or E_SEWER_PLAN	EXISTING VERTICAL BEND FOR SEW
	Geodetic Bench Mark	LEGAL	GEODETTIC BENCH MARK LOCATION
	Guy Anchor	E_HYDRO_PLAN	UTILITY POLE SUPPORT ANCHOR
	Hydro Pole w_Street Light	E_HYDRO_PLAN	HYDRO POLE WITH STREET LIGHT A
	Hydro Pole	E_HYDRO_PLAN	HYDRO POLE
	Iron Bar	LEGAL	PROPERTY BARS
	Mail Box	0	MAIL BOX
	MTS Pole	E_MTS_PLAN	MTS POLE
	P_Profile_Ellipse	P_WATER_PROFILE or P_SEWER_PROFILE	PROPOSED SEWER OR WATER CRO
	P_Profile_Flow Arrow	P_SEWER_PROFILE	PROPOSED SEWER FLOW DIRECTIO
	P_Profile_Hydrant Top	P_WATER_PROFILE	SECTION OF HYDRANT ABOVE THE
	P_Profile_Pipe End	P_WATER_PROFILE or P_SEWER_PROFILE	PIPE CONTINUATION AT LIMITS OF P

Figure 25
(For a larger view see Appendix P)

























WATER BLOCKS			
BLOCK SYMBOL	BLOCK NAME (.dwg)	LAYER NAME	DESCRIPTION
	W-ANODE	AG_WATER_ANODE	PROPOSED ANODE
	W-AQ-MH	AG_AQ_PRESS_MANHOLE	PROPOSED AQUEDUCT PRESSURE MANHOLE
	W-ARVALVE	AG_WATER_RELEASE_AIRVALVE	PROPOSED AIR RELEASE VALVE
	W-BEND_11	AG_WATER_BEND	PROPOSED 11.25° WATER BEND
	W-BEND_22	AG_WATER_BEND	PROPOSED 22.5° WATER BEND
	W-BEND_45	AG_WATER_BEND	PROPOSED 45° WATER BEND
	W-BEND_90	AG_WATER_BEND	PROPOSED 90° WATER BEND
	W-V BEND	AG_WATER_BEND	PROPOSED VERTICAL WATER BEND
	W-BOVALVE	AG_WATER_BLOW_OFF_VALVE	PROPOSED BLOW-OFF VALVE
	W-CATHOD	AG_WATER_ANODE	PROPOSED ANODE INSTALLED AS CATHODIC PROTECTION
	W-CATHOD-MON STATION	AG_CATHODIC PROTECTION MONITORING SYSTEM	PROPOSED CATHODIC PROTECTION MONITORING STATION
	W-COUPLING	AG_WATER_COUPLER	PROPOSED WATER COUPLING
	W-CROSS	AG_WATER_CROSS	PROPOSED WATER CROSS
	W-CURBSTOP	AG_WATER_CURB_STOP	PROPOSED CURB STOP
	W-DRVALVE	AG_WATER_DRAIN_VALVE	PROPOSED DRAIN VALVE
	W-E-HYD	AG_WATER_EXIST_HYDRANT	EXISTING HYDRANT
	W-E-VALVE	AG_WATER_EXIST_VALVE	EXISTING WATER VALVE
	W-HYD TEE	AG_WATER_HYDRANT_TEE	PROPOSED HYDRANT TEE AT WATERMAIN
	W-HYD VALVE	AG_WATER_HYDRANT_VALVE	PROPOSED HYDRANT VALVE
	W-HYD	AG_WATER_HYDRANT	PROPOSED HYDRANT
	W-PLUG	AG_WATER_PLUG	PROPOSED WATER PLUG
	W-REDUCER	AG_WATER_REDUCER	PROPOSED WATER REDUCER
	W-TBLOCK	AG_WATER_THRUSTBLOCK	PROPOSED WATERMAIN THRUSTBLOCK
	W-TEE	AG_WATER_TEE	PROPOSED WATER TEE
	W-VALVE	AG_WATER_VALVE	PROPOSED WATER VALVE

Figure 26

STANDARD BLOCKS			
BLOCK SYMBOL	BLOCK NAME (.dwg)	LAYER NAME	DESCRIPTION
/	A_11 Bend	E_WATER_ABAND_PLAN or E_SEWER_ABAND_PLAN	ABANDONED 11.25° BENDS FOR SEWER OR WATER
/	A_22 Bend	E_WATER_ABAND_PLAN or E_SEWER_ABAND_PLAN	ABANDONED 22.5° BENDS FOR SEWER OR WATER
∠	A_45 Bend	E_WATER_ABAND_PLAN or E_SEWER_ABAND_PLAN	ABANDONED 45° BENDS FOR SEWER OR WATER
⊥	A_90 Bend	E_WATER_ABAND_PLAN or E_SEWER_ABAND_PLAN	ABANDONED 90° BENDS FOR SEWER OR WATER
◁	A_Reducer	E_WATER_ABAND_PLAN or E_SEWER_ABAND_PLAN	ABANDONED REDUCER FOR SEWER OR WATER
□	A_Catch Basin	E_SEWER_ABAND_PLAN	ABANDONED CATCH BASIN
⊥	E_Tee	E_WATER_ABAND_PLAN or E_SEWER_ABAND_PLAN	ABANDONED TEE FOR SEWER AND WATER
⊥	A_Cross	E_WATER_ABAND_PLAN or E_SEWER_ABAND_PLAN	ABANDONED CROSS FOR SEWER AND WATER
▽	A_Curb Inlet	E_SEWER_ABAND_PLAN	ABANDONED CURB INLET
♂	A_Curb Stop	E_WATER_ABAND_PLAN	ABANDONED CURB STOPS
⊗	A_Valve	E_WATER_ABAND_PLAN or E_SEWER_ABAND_PLAN	ABANDONED VALVE FOR SEWER AND WATER
○	A_Manhole	E_SEWER_ABAND_PLAN	ABANDONED MANHOLES
	A_Vertical Bend	E_WATER_ABAND_PLAN or E_SEWER_ABAND_PLAN	ABANDONED VERTICAL BEND FOR SEWER AND WATER
⌋	A_Plug	E_WATER_ABAND_PLAN or E_SEWER_ABAND_PLAN	ABANDONED PLUG ON SEWER OR WATER
∩	A_Profile_Ellipse	E_WATER_ABAND_PLAN or E_SEWER_ABAND_PLAN	INTERSECTING SEWER OR WATER PIPE ON THE PROFILE
×	A_Profile_Valve	E_WATER_ABAND_PLAN or E_SEWER_ABAND_PLAN	ABANDONED VALVES IN PROFILE

Figure 27

SEWER BLOCKS			
BLOCK SYMBOL	BLOCK NAME (.dwg)	LAYER NAME	DESCRIPTION
	S-BEND_11	AG_SEWER_BEND	PROPOSED 11.25° SEWER BEND
	S-BEND_22	AG_SEWER_BEND	PROPOSED 22.5° SEWER BEND
	S-BEND_45	AG_SEWER_BEND	PROPOSED 45° SEWER BEND
	S-BEND_90	AG_SEWER_BEND	PROPOSED 90° SEWER BEND
	S-V BEND	AG_SEWER_BEND	PROPOSED VERTICAL SEWER BEND
	S-CB TEE	AG_SEWER_CB_TEE	PROPOSED CATCHBASIN LEAD TEE AT SEWER MAIN
	S-CB	AG_SEWER_CB	PROPOSED CATCHBASIN
	S-CI	AG_SEWER_CI	PROPOSED CURB INLET
	S-COUPLING	AG_SEWER_COUPLER	PROPOSED SEWER COUPLING
	S-E-CB	AG_SEWER_EXIST_CB	EXISTING CATCHBASIN
	S-E-CI	AG_SEWER_EXIST_CI	EXISTING CURB INLET
	S-E-FLOW	AG_SEWER_EXIST_MAIN_LINEDIR	FLOW DIRECTION ARROW ON AN EXISTING SEWERMAIN
	S-E-MH	AG_SEWER_EXIST_MANHOLE	EXISTING MANHOLE
	S-FLOW	AG_SEWER_MAIN_LINEDIR	FLOW DIRECTION ARROW ON A PROPOSED SEWERMAIN
	S-MH	AG_SEWER_MANHOLE	PROPOSED MANHOLE
	S-PLUG	AG_SEWER_PLUG	PROPOSED SEWER PLUG
	S-REDUCER	AG_SEWER_REDUCER	PROPOSED SEWER REDUCER
	S-TBLOCK	AG_SEWER_THRUSTBLOCK	PROPOSED SEWERMAIN THRUST BLOCK
	S-TEE	AG_SEWER_TEE	PROPOSED SEWER TEE
	S-VALVE	AG_SEWER_VALVE	PROPOSED SEWER VALVE
	S-GATE VALVE	AG_SEWER_GATE VALVE	PROPOSED SEWER GATE VALVE
	S-YARD DRAIN	AG_SEWER_YARD_DRAIN_INLET	PROPOSED YARD DRAIN

OPEN CHANNEL BLOCKS			
BLOCK SYMBOL	BLOCK NAME (.dwg)	LAYER NAME	DESCRIPTION
	OC-CB	AG_OC_INLET_OUTLET_CB	PROPOSED OPEN CHANNEL CATCH BASIN
	OC-E-CB	AG_OC_INLET_OUTLET_E_CB	EXISTING OPEN CHANNEL CATCH BASIN
	OC-MH	AG_OC_INLET_OUTLET_MH	PROPOSED OPEN CHANNEL MANHOLE
	OC-E-MH	AG_OC_INLET_OUTLET_E_MH	EXISTING OPEN CHANNEL MANHOLE

Figure 28

4.1.6 Service Charts

Water Service Chart

WATER SERVICE INFORMATION

ADDRESS	SIZE (mm) MATERIAL (STREET)	SIZE (mm) MATERIAL (PROP.)	SHORT & LONG MEASUREMENT	LINEAR DISTANCE (1) CORP LOCATION (2)	REMARKS
49 ANYMANS CRESCENT RESIDENTIAL	20 CU	20 CU	3.36 WEL HSE 94.563 EEL LEFT ST	13.7 2.4 W OF S/C	RECONNECT SERVICE -
* 53 ANYMANS CRESCENT RESIDENTIAL	20 CU	20 CU	3.36 WEL HSE 117.484 EEL LEFT ST	19.0 3.3 E OF S/C	RENEW TO \varnothing W/20 CU -
* 55 ANYMANS CRESCENT RESIDENTIAL	20 CU	20 CU	3.50 WEL HSE 125.431 EEL LEFT ST	19.4 3.7 W OF S/C	RENEW TO \varnothing W/20 CU -

(1) LINEAR DISTANCE FROM THE S/C TO THE CORP USED ALONG BENDS & CURVED R.O.W.

(2) DIRECTION FROM S/C

* SERVICES TO BE RENEWED TO \varnothing . ALL OTHERS TO BE RECONNECTED

Figure 27

Sewer Service Chart

SEWER SERVICE INFORMATION

ADDRESS	SIZE (mm) MATERIAL	\varnothing DIST JUNCTION TIE	REMARKS
122 STANDARD AVE RESIDENTIAL	150 PVC	8.79 W OF EL 33.98 W OF 1ST MH W RIGHT	- -
123 STANDARD AVE RESIDENTIAL	150 CLAY	16.69 E OF WL 33.49 W OF 1ST MH W RIGHT	- -
127 STANDARD AVE RESIDENTIAL	150 AC	5.38 E OF WL 11.17 W OF 1ST MH W RIGHT	- -
129 STANDARD AVE RESIDENTIAL	150 CLAY	16.27 E OF WL 3.38 W OF 1ST MH W RIGHT	- -

Figure 28

Sewer Televising Chart

SEWER JUNCTION INFORMATION FROM SEWER VIDEO INSPECTION		
SEWER ID S-MAXXXXXXXXXX2		
DISTANCE FROM MH ID S-MHXXXXXXXXX2		
DISTANCE	DIAMETER	CLOCK
3.4	150	9
11.2	150	9
13.2	200	3
33.5	150	8
34.0	150	4

Figure 29

4.1.7 Dimensioning

All drawings require existing utilities, legal limits, curbs, and proposed works to be dimensioned in Paper Space. All dimensions shall have the correct Dim scale linear value based on the drawings scale. Drawings with a 1:250 scale will have a Dim scale value of -0.2500. Drawings with a 1:500 scale will have a Dim scale value of -0.500. Drawings with a 1:750 scale will have a Dim scale of -0.750.

Typical Dimensions-Existing Items shall be set as follows:

Layer=TEXT_RED
Font=simplex.shx (See Figure 31 in section 4.1.8 Fonts)
Text Height=1.8
Text Offset=0.3
Oblique Angle=0 (except for existing legal dimensions which shall have an Oblique Angle of 15)
Text Placement=Centered (Both vertical and horizontal)
Arrows size=2.0 and Closed Filled
Ext line and Ext line offset=minimum 1.0 and maximum 2.0
Dim line forced set=Off
Dim line inside set=On
Precision=0.00 except legal dimensions which=0.000
(See Figure 30, next page)

Typical Dimensions-Proposed Items shall be set as follows:

Layer=TEXT_GREEN
Font=simplex.shx (See Figure 31 in section 4.1.8. Fonts)
Text Height=2.4
Text Offset=1.0
Oblique Angle=0
Text Placement=Centered (Both vertical and horizontal)
Arrows size=3.00 and Closed Filled
Ext line and Ext line offset=minimum 1.0 and maximum 2.0
Dim line forced set=Off
Dim line inside set=On
Precision=0.00 except legal dimensions which=0.000
(See Figure 30, next page)

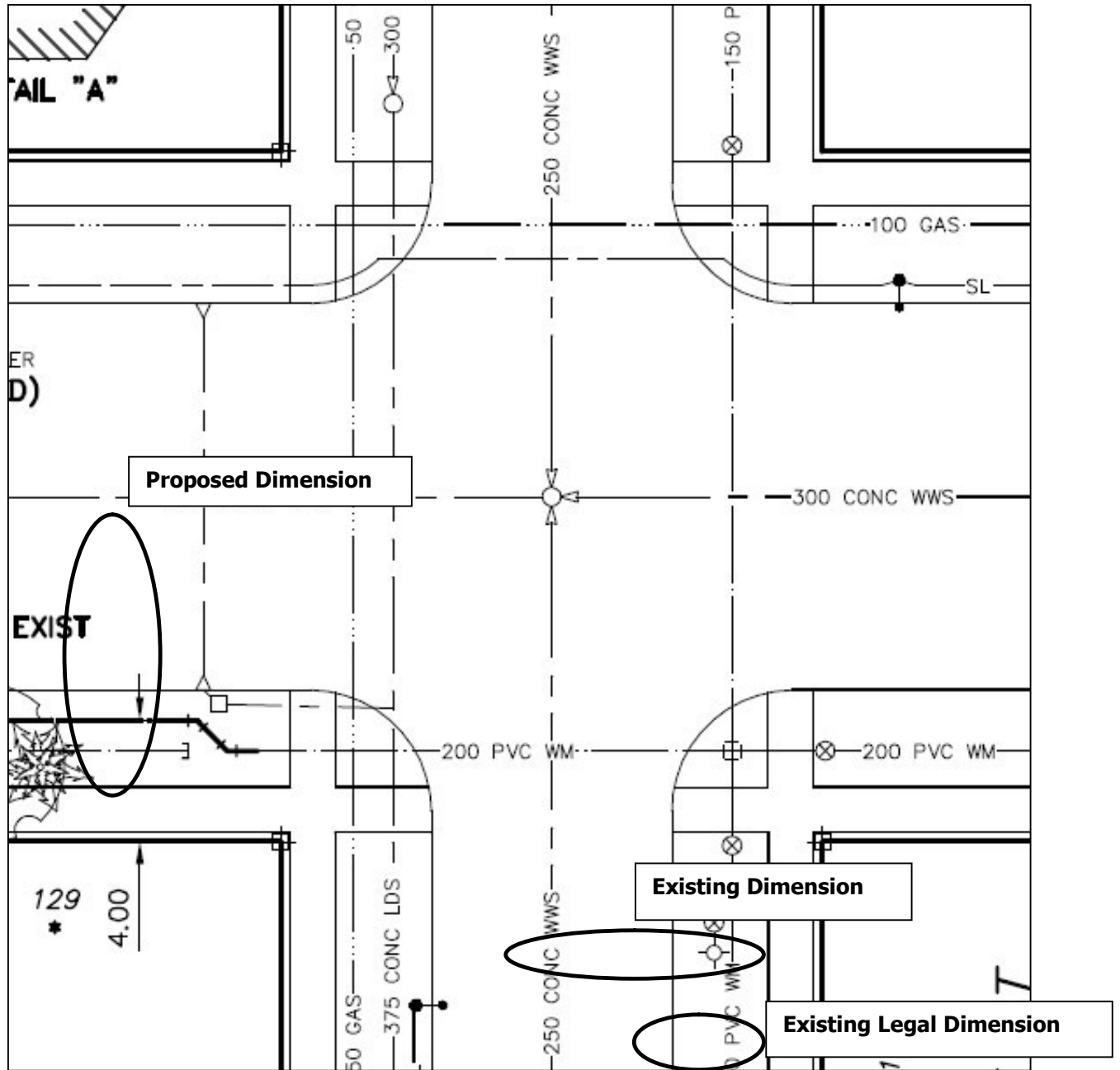

Figure 30

4.1.8 Fonts

TEXT IN PAPER SPACE (TITLE BLOCK)							
FONT USE	LAYER	COLOR	PLOT STYLE	SIZE	OBLIQUING ANGLE	WIDTH FACTOR	FONT FILE NAME
CITY OF WINNIPEG	DWG_TB_TEXT3	CYAN	COLOR_4	5.5	0.0000	1.3500	x-hlv1d.shx
WATER AND WASTE DEPARTMENT	DWG_TB_TEXT3	CYAN	COLOR_4	3.5	0.0000	0.0000	simplex.shx
ENGINEERING DIVISION	DWG_TB_TEXT3	CYAN	COLOR_4	3.5	0.0000	0.0000	simplex.shx
YEAR AND WORK TYPE	DWG_TB_TEXT3	CYAN	COLOR_4	3.5	0.0000	0.0000	simplex.shx
STREET NAME	DWG_TB_TEXT3	BLUE	COLOR_5	5.0	0.0000	0.0000	simplex.shx
DRAWING LIMITS	DWG_TB_TEXT3	CYAN	COLOR_4	3.5	0.0000	0.0000	simplex.shx
SHEET NUMBER	DWG_TB_TEXT3	CYAN	COLOR_4	3.5	0.0000	0.0000	simplex.shx
CITY DRAWING NUMBER	DWG_TB_TEXT3	CYAN	COLOR_4	3.5	0.0000	0.0000	simplex.shx
DESIGNED BY INITIALS	DWG_TB_TEXT1	YELLOW	COLOR_2	2.5	0.0000	0.0000	simplex.shx
DRAWN BY INITIALS	DWG_TB_TEXT1	YELLOW	COLOR_2	2.5	0.0000	0.0000	simplex.shx
CHECKED BY INITIALS	DWG_TB_TEXT1	YELLOW	COLOR_2	2.5	0.0000	0.0000	simplex.shx
APPROVED BY INITIALS	DWG_TB_TEXT1	YELLOW	COLOR_2	2.5	0.0000	0.0000	simplex.shx
HORIZONTAL & VERTICAL DRAWING SCALES	DWG_TB_TEXT1	YELLOW	COLOR_2	2.5	0.0000	0.0000	simplex.shx
DRAWING DATE	DWG_TB_TEXT1	YELLOW	COLOR_2	2.4	0.0000	0.0000	simplex.shx
RELEASED FOR CONSTRUCTION DATE	DWG_TB_TEXT1	YELLOW	COLOR_2	2.5	0.0000	0.0000	simplex.shx
CONSULTANT DRAWING NUMBER	DWG_TB_TEXT3	GREEN	COLOR_3	2.5	0.0000	0.0000	simplex.shx
CONSTRUCTION COMPLETION DATE	DWG_TB_TEXT1	YELLOW	COLOR_2	2.0	0.0000	0.0000	simplex.shx
BOX DESCRIPTIONS	DWG_TB_TEXT2	RED	COLOR_1	1.8	0.0000	0.0000	simplex.shx
DRAWING METADATA	DWG_TB_TEXT2	RED	COLOR_1	1.8	0.0000	0.0000	simplex.shx

TEXT IN MODEL SPACE							
FONT USE	LAYER	COLOR	PLOT STYLE	SIZE	OBLIQUING ANGLE	WIDTH FACTOR	FONT FILE NAME
PROPERTY ADDRESSES	TEXT_ADDRESS	GREEN	COLOR_3	0.6	15.0000	0.0000	simplex.shx
ABANDONED SEWER DESCRIPTION	TEXT_SEWER	DARK GREY	COLOR_8	0.45	0.0000	0.0000	simplex.shx
ABANDONED WATER DESCRIPTION	TEXT_WATER	DARK GREY	COLOR_8	0.45	0.0000	0.0000	simplex.shx
EXISTING SEWER DESCRIPTION	TEXT_SEWER	RED	COLOR_1	0.45	0.0000	0.0000	simplex.shx
EXISTING WATER DESCRIPTION	TEXT_WATER	RED	COLOR_1	0.45	0.0000	0.0000	simplex.shx
PROPOSED SEWER DESCRIPTION	TEXT_SEWER	CYAN	COLOR_4	0.6	0.0000	0.0000	simplex.shx
PROPOSED WATER DESCRIPTION	TEXT_WATER	CYAN	COLOR_4	0.6	0.0000	0.0000	simplex.shx
EASEMENT NUMBER	TEXT_GREEN	GREEN	COLOR_3	0.45	0.0000	0.0000	simplex.shx
OTHER UTILITY DESCRIPTION	TEXT_RED	RED	COLOR_1	0.45	0.0000	0.0000	simplex.shx

Figure 31

TEXT IN PAPER SPACE (PLAN)							
FONT USE	LAYER	COLOR	PLOT STYLE	SIZE	OBLIQUING ANGLE	WIDTH FACTOR	FONT FILE NAME
PROPERTY ADDRESSES	TEXT_ADDRESS	GREEN	COLOR_3	2.4	15.0000	0.0000	simplex.shx
ABANDONED SEWER DESCRIPTION	TEXT_SEWER	DARK GREY	COLOR_8	1.8	0.0000	0.0000	simplex.shx
ABANDONED WATER DESCRIPTION	TEXT_WATER	DARK GREY	COLOR_8	1.8	0.0000	0.0000	simplex.shx
EXISTING SEWER DESCRIPTION	TEXT_SEWER	RED	COLOR_1	2.4	0.0000	0.0000	simplex.shx
EXISTING WATER DESCRIPTION	TEXT_WATER	RED	COLOR_1	1.8	0.0000	0.0000	simplex.shx
PROPOSED SEWER DESCRIPTION	TEXT_SEWER	CYAN	COLOR_4	2.4	0.0000	0.0000	simplex.shx
PROPOSED WATER DESCRIPTION	TEXT_WATER	CYAN	COLOR_4	2.4	0.0000	0.0000	simplex.shx
EASEMENT NUMBER	TEXT_GREEN	GREEN	COLOR_3	1.8	0.0000	0.0000	simplex.shx
OTHER UTILITY DESCRIPTION	TEXT_RED	RED	COLOR_1	1.8	0.0000	0.0000	simplex.shx
NOTES FOR EXISTING	TEXT_RED	RED	COLOR_1	1.8	0.0000	0.0000	simplex.shx
NOTES FOR PROPOSED WORK	TEXT_SEWER	CYAN	COLOR_4	2.4	0.0000	0.0000	simplex.shx
CAUTION NOTE	TEXT_GREEN	GREEN	COLOR_3	3.5	0.0000	0.0000	simplex.shx
CHAINAGE NOTE	TEXT_GREEN	GREEN	COLOR_3	3.5	0.0000	0.0000	simplex.shx
EXISTING DIMENSIONS	TEXT_RED	RED	COLOR_1	1.8	0.0000	0.0000	simplex.shx
EXISTING DETAIL TEXT	TEXT_RED	RED	COLOR_1	1.8	0.0000	0.0000	simplex.shx
PROPOSED DETAIL TEXT	TEXT_CYAN	CYAN	COLOR_4	2.4	0.0000	0.0000	simplex.shx
PROPOSED DIMENSIONS	TEXT_ADDRESS	GREEN	COLOR_3	2.4	15.0000	0.0000	simplex.shx
STREET NAMES	TEXT_ADDRESS	CYAN	COLOR_4	5.0	15.0000	0.0000	simplex.shx
SERVICE TABLE TITLES	DWG_NOTES2	GREEN	COLOR_3	3.5	0.0000	0.0000	simplex.shx
SERVICE TABLE BODY (EXISTING)	DWG_NOTES1	RED	COLOR_1	1.8	0.0000	0.0000	simplex.shx
SERVICE TABLE BODY (RENEWED)	DWG_NOTES2	GREEN	COLOR_3	1.8	0.0000	0.0000	simplex.shx
SEWER TELEVISIONING TABLE TITLE	DWG_NOTES1	RED	COLOR_1	1.8	0.0000	0.0000	simplex.shx
SEWER TELEVISIONING TABLE SEWER ID NUMBER	DWG_NOTES1	YELLOW	COLOR_2	2.4	0.0000	0.0000	simplex.shx
SEWER TELEVISIONING TABLE BODY	DWG_NOTES1	RED	COLOR_1	1.8	0.0000	0.0000	simplex.shx
MATERIALS LIST TITLE & HEADINGS	DWG_NOTES2	GREEN	COLOR_3	1.8	0.0000	0.0000	simplex.shx
MATERIALS LIST BODY	DWG_NOTES1	YELLOW	COLOR_2	1.8	0.0000	0.0000	simplex.shx
MATERIALS LIST CONTRACTOR NAME	DWG_NOTES2	GREEN	COLOR_3	3.0	0.0000	0.0000	simplex.shx
DETAIL & SECTION NAME	DWG_NOTES2	GREEN	COLOR_3	3.0	15.0000	0.0000	simplex.shx
DETAIL & SECTION SCALE	DWG_NOTES1	YELLOW	COLOR_2	1.8	0.0000	0.0000	simplex.shx
MATCHLINE	DWG_NOTES2	CYAN	COLOR_4	3.0	0.0000	0.0000	simplex.shx

Figure 31 (Continued)

TEXT IN PAPER SPACE							
(PROFILE)							
FONT USE	LAYER	COLOR	PLOT STYLE	SIZE	OBLIQUING ANGLE	WIDTH FACTOR	FONT FILE NAME
EXISTING SEWER DESCRIPTION	TEXT_SEWER	YELLOW	COLOR_2	1.8	0.0000	0.0000	simplex.shx
EXISTING WATER DESCRIPTION	TEXT_WATER	YELLOW	COLOR_2	1.8	0.0000	0.0000	simplex.shx
PROPOSED SEWER DESCRIPTION	TEXT_SEWER	CYAN	COLOR_4	2.4	0.0000	0.0000	simplex.shx
PROPOSED WATER DESCRIPTION	TEXT_WATER	CYAN	COLOR_4	2.4	0.0000	0.0000	simplex.shx
NOTES FOR EXISTING	TEXT_RED	RED	COLOR_1	1.8	0.0000	0.0000	simplex.shx
NOTES FOR PROPOSED WORK	TEXT_CYAN	CYAN	COLOR_4	2.4	0.0000	0.0000	simplex.shx
EXISTING DIMENSIONS	TEXT_RED	RED	COLOR_1	1.8	0.0000	0.0000	simplex.shx
PROPOSED DIMENSIONS	TEXT_GREEN	GREEN	COLOR_3	2.4	0.0000	0.0000	simplex.shx
CHAINAGES	TEXT_CYAN	CYAN	COLOR_4	2.4	0.0000	0.0000	simplex.shx
ELEVATION DATUM	TEXT_CYAN	CYAN	COLOR_4	3.5	15.0000	0.0000	simplex.shx
EXISTING INVERTS & ELEVATIONS	TEXT_RED	RED	COLOR_1	1.8	0.0000	0.0000	simplex.shx
PROPOSED INVERTS & ELEVATIONS	TEXT_CYAN	CYAN	COLOR_4	2.4	0.0000	0.0000	simplex.shx

TEXT IN PAPER SPACE							
(TITLE PAGE - A1)							
FONT USE	LAYER	COLOR	PLOT STYLE	SIZE	OBLIQUING ANGLE	WIDTH FACTOR	FONT FILE NAME
CITY OF WINNIPEG	TEXT_CYAN	CYAN	COLOR_4	18.0	0.0000	1.3500	x-hlv1d.shx
WATER AND WASTE DEPARTMENT	TEXT_BLUE	BLUE	COLOR_5	12.0	0.0000	0.0000	x-hlv1d.shx
ENGINEERING DIVISION	TEXT_BLUE	BLUE	COLOR_5	15.0	0.0000	0.0000	x-hlv1d.shx
CONTRACT AND BID OPPORTUNITY NUMBERS	TEXT_CYAN	CYAN	COLOR_4	9.0	0.0000	0.0000	x-hlv1d.shx
KEY MAP	TEXT_CYAN	CYAN	COLOR_4	6.0	0.0000	0.0000	x-hlv1d.shx

TEXT IN MODEL SPACE							
(TITLE PAGE - A1)							
FONT USE	LAYER	COLOR	PLOT STYLE	SIZE	OBLIQUING ANGLE	WIDTH FACTOR	FONT FILE NAME
STREET NAMES	TEXT_RED	RED	COLOR_1	8.0	0.0000	0.0000	simplex.shx

Figure 31 (Continued)

4.1.9 Linear Entities - Direction of Flow

All new/proposed features in a GIS Final Drawings will eventually become GIS objects; for this reason, **linear features (or lines), that are drawn to depict sewer entities shall be drawn in the direction of flow of that entity, high elevation to low (upstream to downstream).**

4.1.10 Plot Styles

Plot styles shall by supplied by the WWD and can be found inside the Plot Style folder on the provided cd (See Figure 32 below).

Note: If a consultant/design firm is using that firm’s workflow and layers to produce a drawing, it is of course, not necessary to use this plot style.

These plot styles have been constructed in conjunction with the layering conventions present in the prototype drawings and the colors shall not be changed when giving the finished drawing back to the WWD.

Name	Color 1	Color 2	Color 3	Color 4	Color 5	Color 6	Color 7
Description	Description_1	Description_2	Description_3	Description_4	Description_5	Description_6	Description_7
Color	Black	Black	Black	Black	Black	Black	Black
Enable dithering	Off	Off	Off	Off	Off	Off	Off
Convert to grayscale	Off	Off	Off	Off	Off	Off	Off
Use assigned pen #	7	7	7	7	7	7	7
Virtual pen #	8	7	7	7	7	7	7
Screening	100	100	100	100	100	100	100
Linetype	Use object linetype	Use object linetype	Use object linetype	Use object linetype	Use object linetype	Use object linetype	Use object linetype
Adaptive adjustment	Off	Off	Off	Off	Off	Off	Off
Lineweight	0.1800 mm	0.2500 mm	0.3000 mm	0.5000 mm	0.7000 mm	0.2000 mm	0.2500 mm
Line End Style	Use object end style	Use object end style	Use object end style	Use object end style	Use object end style	Use object end style	Use object end style
Line Join style	Use object join style	Use object join style	Use object join style	Use object join style	Use object join style	Use object join style	Use object join style
Fill Style	Use object fill style	Use object fill style	Use object fill style	Use object fill style	Use object fill style	Use object fill style	Use object fill style

Figure 32

(For a larger view see Appendix Q)

4.1.11 X-Refs and Aerial Images

X-references and image attachments are not to be used in the production of GIS Final Drawings for the WWD.

4.1.12 Base Lines and Chainages

The base line shall be located along the nearest property line parallel to the proposed work. If possible 1+00.000 shall be located at the property line intersection closest to the start of the proposed work. The chainage is shown in the profile at 25m increments for the scale 1:250 and at 50m

increments for 1:500. A note should be placed in the plan portion of the drawing indicating the location of the baseline (See Figure 33 below).

NOTE: CHAINAGES SHOWN ARE ALONG
N E OF STANDARD AVE.

Figure 33

4.1.13 Survey

The survey of the existing infrastructure that is performed as part of any construction project for the Department is important for confirming the location in the GIS. At the time the Final GIS drawing is integrated with the GIS, a discrepancy may exist between the existing configuration in GIS and the new works. The survey may be referenced as a means to help resolve this conflict. **For this reason, it is important for all of the survey information to remain as part of the Final GIS drawing.**

Three (3) layers are provided to be used for survey:

- ZPTWATER (For all water related survey)
- ZPTSEWER (For all sewer related survey)
- ZPTMISC (For any additional topography/legal/utility survey)

Please see section **3.4.6. Layering Conventions** for a complete list of Final GIS drawing layers.

4.1.14 File Names

When submitting AutoCAD drawing files, the drawing file name should be the City of Winnipeg drawing number supplied by the Department.

Example:

- (Water) D-#####.DWG
- (Sewer) XXXXXX.DWG
- (Land Drainage) LD-#####.DWG
- (GIS Final) GIS-###-2013_1 (based on tender number)

4.1.15 Details

All congested design shall be clarified with a detail:

- Blocks shall be at 1/1000

- Line segments are to be drawn not to scale (NTS) (NOTE: make sure all lines are relative to each other regarding lengths)
- Proposed shall be on layer "AG_XXXX"
- Existing line type shall be layer "E_XXXX_"
- Dimension style shall be PRO_DIM
- Notes for construction phase shall be in past tense, notes for record dwg shall be in past tense

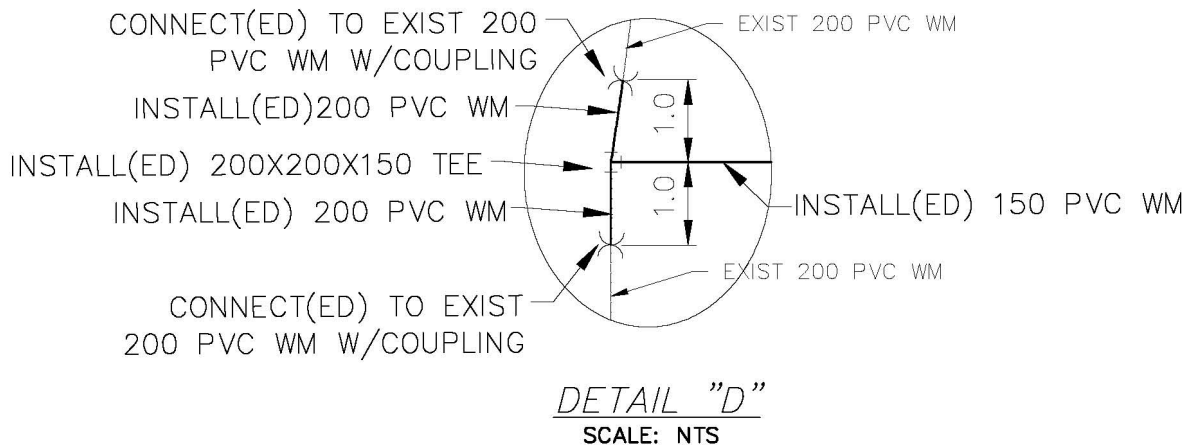

Figure 34

5.0 Standard Measurements of Water and Sewer Customer Connections

The following is a list of appurtenances and reference points for which measurements (e.g. X, Y, and Z coordinates), and attribute information is required as they pertain to water and sewer customer connections.

Water

- Curb stop (aka service box, water service box, or stop cock)
- Corporation stop (aka Corp, or Corp Stop)
- Tie-in at building
- Couplers (unions)
- Fittings (bend, reducer, tee, cross, wye)

Sewer

- Point of intersection of pipe at property line
- Point of intersection at building
- Fittings (Bends, Wye)
- Standpipe

5.1 Water Connections: Building Service Record

5.1.1 Curb Stop

- Long measurement – distance from nearest intersecting street line, measured along the property line, or reasonable projection thereof, to the curb stop.

Example: "120.300 WWL ANY ST"

Or: "45.400 WWL E LEG ANY ST"

- Short measurement – distance from most "effective" outside building line of the foundation (no cantilevers) to the curb stop. Outside building line of the garage is included, measure to right angles of the building.

Example: "4.20 WEBL (where "B" stands for building)

- Out of building – distance from nearest building line (including front of garage if applicable) to the curb stop, measured at a right angle.

Example: "7.60 OUT"

- Depth of curb stop – vertical distance (depth) from ground surface to curb stop to curb valve.

Example: "2.4"

- Street serviced from – the street in which the water main resides to the water connection in question is connected to.

Example: "SAMPLE ST"

5.1.2 Corporation Stop

- Long measurement distance from nearest intersecting street line, measured along the water main, or reasonable projection thereof, to the corporation stop.

Example "121.500 WWL Any St

- Short measurement - distance between curb stop and corporation stop, measured at right angles to the building, or reasonable projection thereof, measured along the water main.

Example: "0.60 W SC (where "SC" stands for stop cock)

- Depth at water main - vertical distance (depth) from ground surface at corporation stops to top of water main.

Example: "2.5"

- Reverse tap – is there a reverse tap on the water connection to the water main.

Example: "REVERSE TAP YES NO

5.1.3 Tie-In at building

- Short measurement - distance from most 'effective' building line to point of intersection of water connection leading into building.

Example: "3.70 EWBL"

- Depth at building line - vertical distance (depth) from ground surface at point of intersection of water connection with building line to the water connection.

Example: "2.1"

5.1.4 Couplers (unions)

- Measurement - distance from curb stop or water main (whichever is more effective/applicable) to the coupler, measured along the line of the water connection.

Example: "1.2 N WM" (where "WM" stands for water main)

Or: "1.4 S SC" (where "SC" stands for stop cock)

5.1.5 Anodes

- Installed - yes or no, and at what proximity, and what form of anode

Example: "WAS ANODE INSTALLED YES

"WHAT LOCATION" WATER MAIN NO CURBSTOP

"WHAT FORM:" Continuity Bonding Minneapolis

Standard

Example of Building Water Service Record



Water and Waste Department • Service des eaux et des déchets

BUILDING SERVICE RECORD

Address:
Date Installed: _____ **Inspected By:** _____
Nature of Service: _____

WATER SERVICE

Size: _____ **Material:** _____ **CStop Material:** _____
Corp Material: _____
Street Serviced from: _____
Position of SC: Long _____
Short _____
Position of CC: Long _____
Short _____
Distance SC to St Line: _____
Distance Main-SC: _____
Depth of Main: _____
Depth of Property Line: _____
Connected To: _____ **Pipe Material:** _____
Coupling Location: _____
Reversed Tapped: Yes No **Material:** _____
Continuity Bonding: Yes No
Anodes: Yes No
Water Comments: _____

WASTE WATER SERVICE / LDS SERVICE

Street Serviced from: _____ **Service Size:** _____
Junction Location @ Main: Long: _____
Short: _____
Service Location @ Prop. : Long _____
Short _____
Materials: _____ **Depth at P/L:** _____
BLDG Line Meas.: _____ **Depth at Jct.:** _____
Standpipe Meas.: _____
Fittings Measurements: _____
Sewer Comments: _____

Entered By: _____ **Date Entered:** _____

Signature: _____

Figure 36

Additional Water Service Measurements

This section illustrates how to measure the distance of the corporation stop and the length of the water services.

Along A Curve

CORPORATION MEASUREMENT ALONG BENDS (RENEWED/RECONNECTED SERVICES)

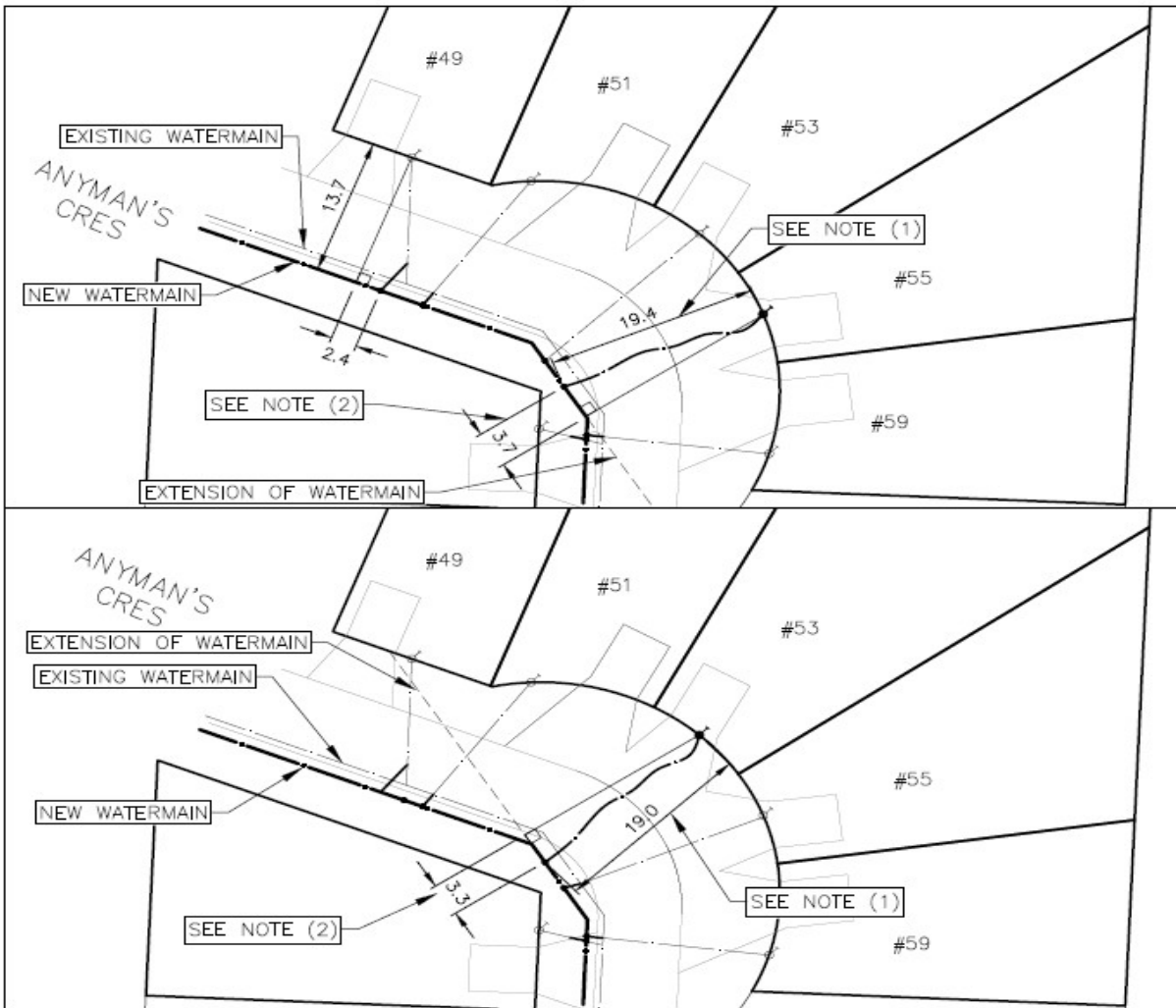

WATER SERVICE INFORMATION

ADDRESS	SIZE (mm) MATERIAL (STREET)	SIZE (mm) MATERIAL (PROP.)	SHORT & LONG MEASUREMENT	LINEAR DISTANCE (1) CORP LOCATION (2)	REMARKS
49 ANYMANS CRESCENT RESIDENTIAL	20 CU	20 CU	3.36 WEL HSE 94.563 EEL LEFT ST	13.7 2.4 W OF S/C	RECONNECTED SERVICE -
53 ANYMANS CRESCENT RESIDENTIAL	20 CU	20 CU	3.36 WEL HSE 117.484 EEL LEFT ST	19.0 3.3 E OF S/C	RENEWED TO \bar{L} -
55 ANYMANS CRESCENT RESIDENTIAL	20 CU	20 CU	3.50 WEL HSE 125.431 EEL LEFT ST	19.4 3.7 W OF S/C	RENEWED TO \bar{L} -

(1) LINEAR DISTANCE FROM THE S/C TO THE CORP USED ALONG BENDS & CURVED R.O.W.
(2) DIRECTION FROM S/C

Figure 37

Cul-De-Sac Example 1

CORPORATION MEASUREMENT ALONG CUL-DE-SAC
(RENEWED SERVICE)

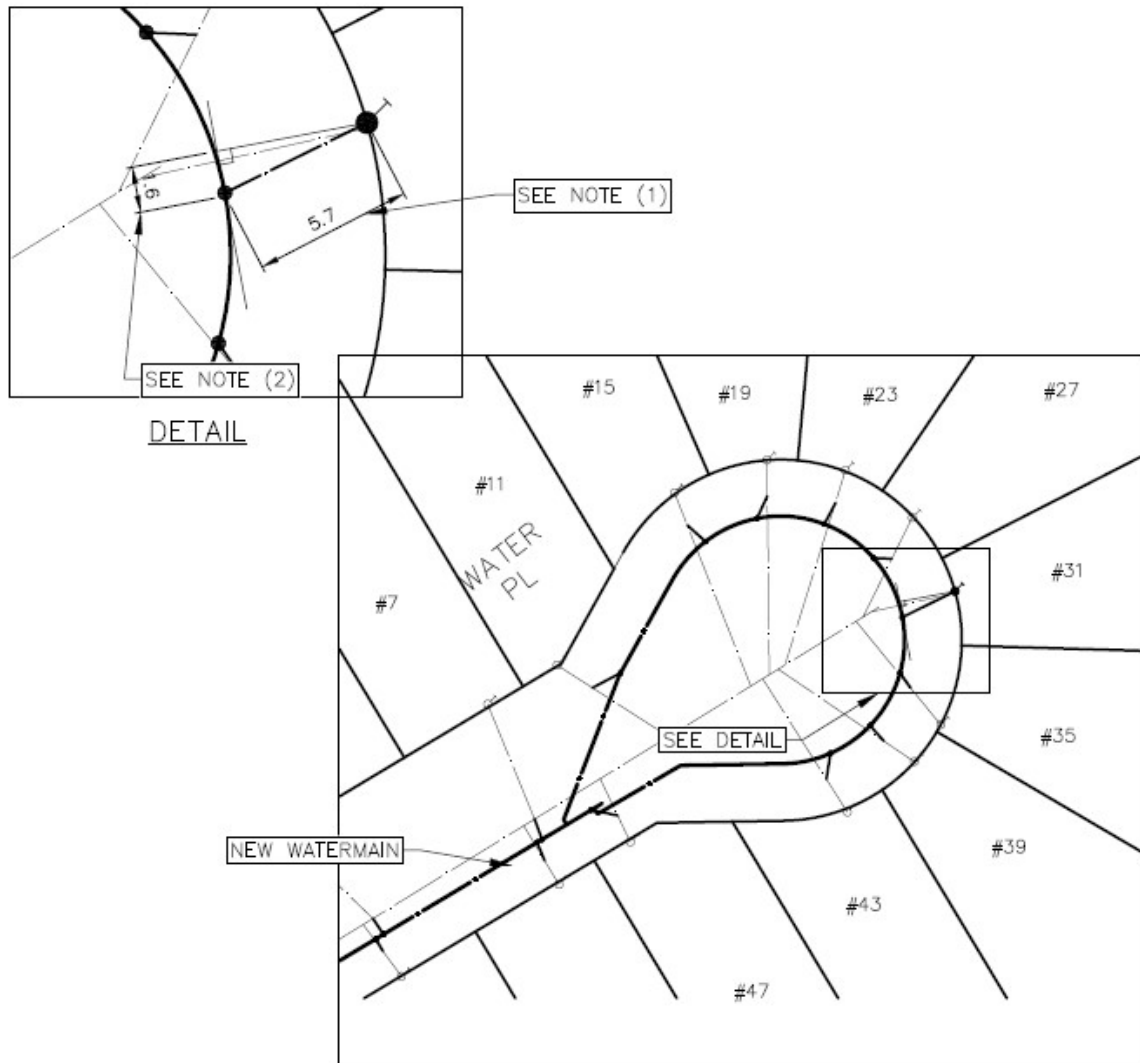

WATER SERVICE INFORMATION

ADDRESS	SIZE (mm) MATERIAL (STREET)	SIZE (mm) MATERIAL (PROP.)	SHORT & LONG MEASUREMENT	LINEAR DISTANCE (1) CORP LOCATION (2)	REMARKS
31 WATER PLACE RESIDENTIAL	20 CU	20 CU	3.44 S OF N LOTLINE 25.910>NNL GUESS LN	5.7 1.6 S OF S/C	RENEWED TO R -

(1) LINEAR DISTANCE FROM THE S/C TO THE CORP USED ALONG BENDS & CURVED R.O.W.

(2) DIRECTION FROM S/C

* SERVICES TO BE RENEWED TO R . ALL OTHERS TO BE RECONNECTED

Figure 38

Cul-De-Sac Example 2

CORPORATION MEASUREMENT ALONG CUL-DE-SAC
(RENEWED/RECONNECTED SERVICES)

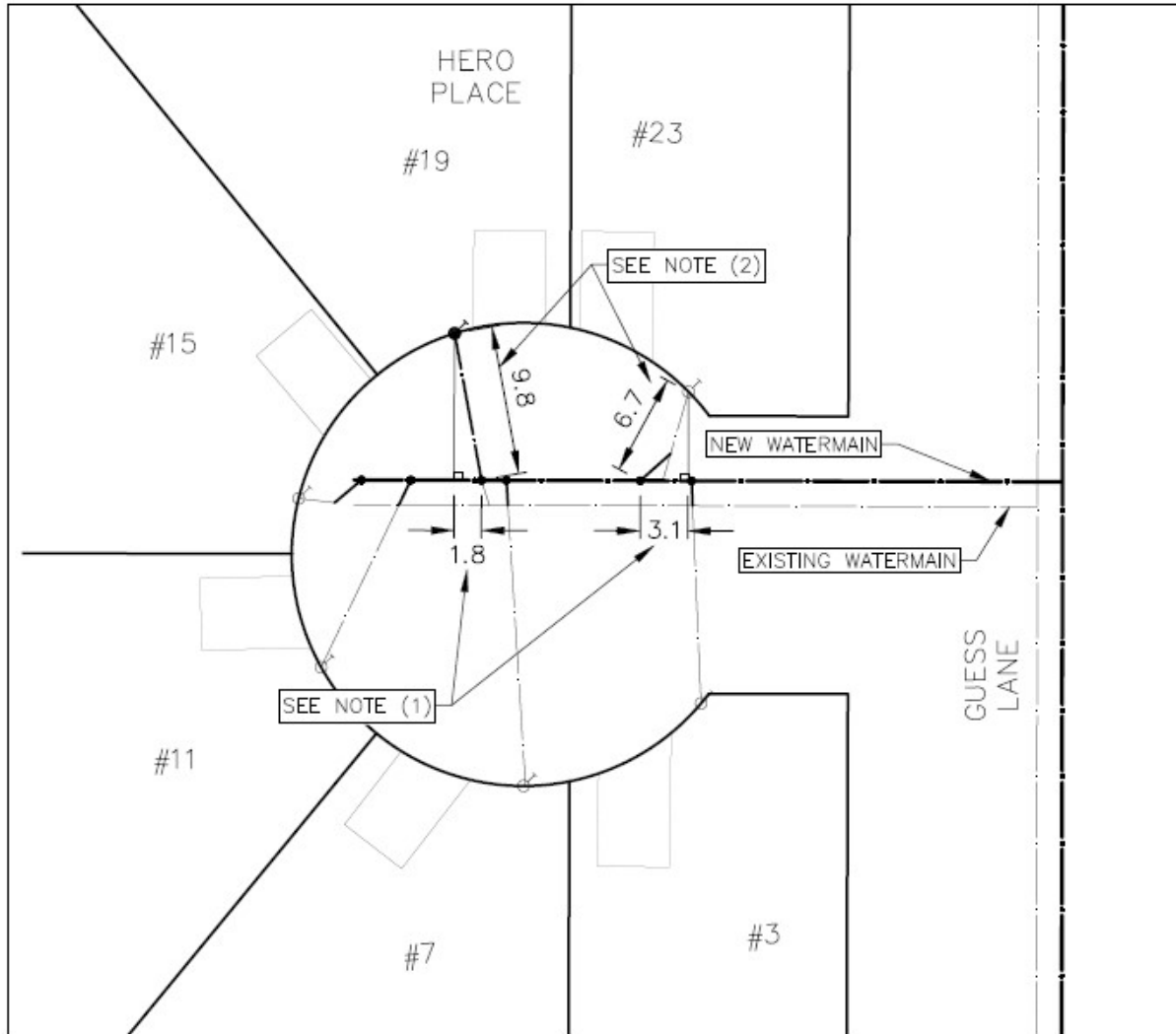

WATER SERVICE INFORMATION

ADDRESS	SIZE (mm) MATERIAL (STREET)	SIZE (mm) MATERIAL (PROP.)	SHORT & LONG MEASUREMENT	LINEAR DISTANCE (1) CORP LOCATION (2)	REMARKS
* 19 HERO PLACE RESIDENTIAL	20 CU	20 CU	7.62 NSL HOUSE 25.910>NNL GUESS LN	9.8 1.8 W OF S/C	RENEWED TO \bar{r} -
19 HERO PLACE RESIDENTIAL	20 CU	20 CU	7.62 NSL HOUSE 25.910>NNL GUESS LN	6.7 3.1 W OF S/C	RECONNECTED SERVICE -

(1) LINEAR DISTANCE FROM THE S/C TO THE CORP USED ALONG BENDS & CURVED R.O.W.

(2) DIRECTION FROM S/C

* SERVICES TO BE RENEWED TO \bar{r} . ALL OTHERS TO BE RECONNECTED

Figure 39

Oversize ISO A1 (594 mm X 841 mm) Along a bend (Record)

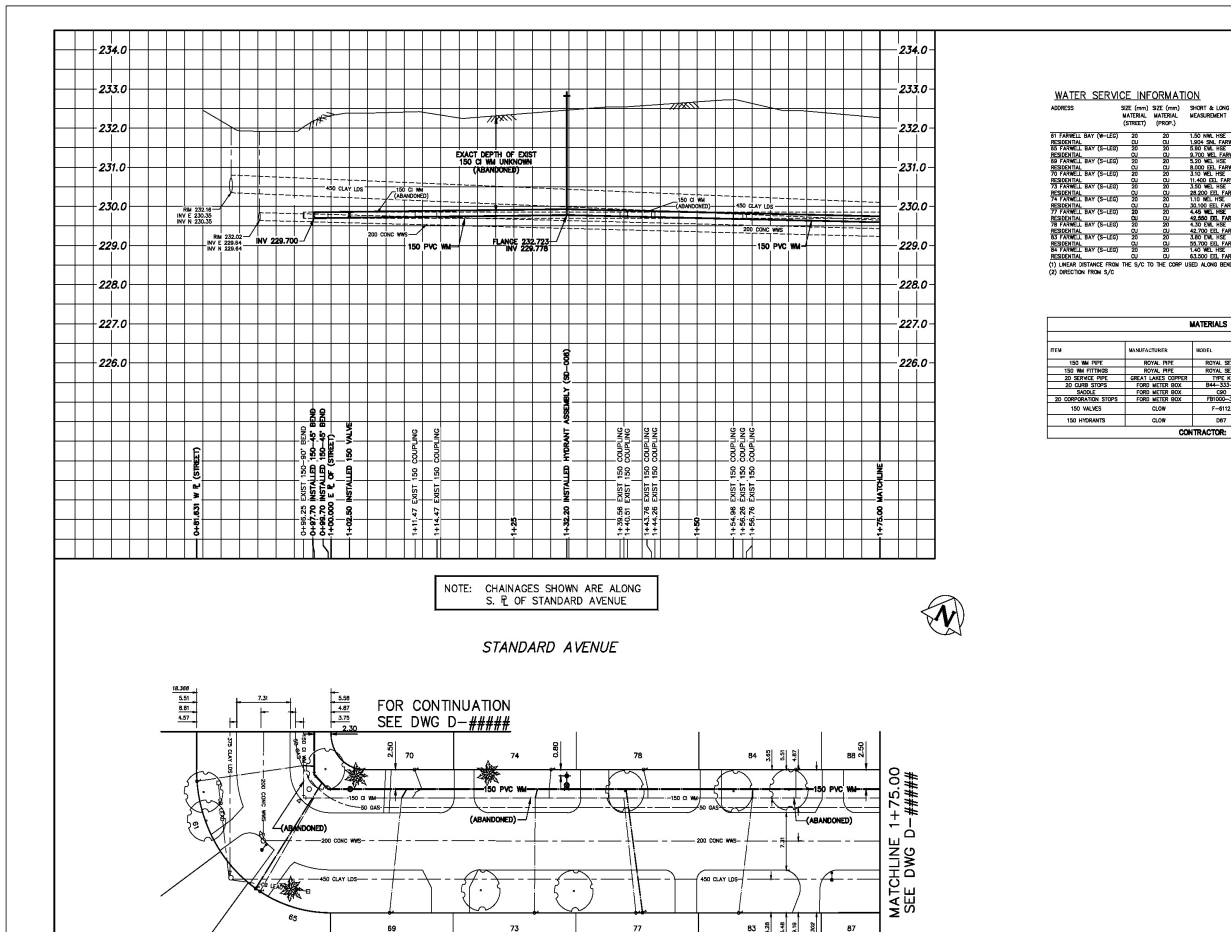

Figure 40
(For a larger view see Appendix AB)

5.2 Sewer Connections

5.2.1 Junction

- Measurement- distance from nearest manhole to junction, measured along sewer main.

Example: "40,7 W MH SAMPLE ST"

Or: "20.4 E MH 1st W ANY AV - #145 ANY AVE*."

- Depth at junction - vertical distance (depth) at junction from ground surface to top of sewer main.

5.2.2 Point of intersection at property line

- Short measurement - distance from most effective building line to point of intersection of sewer connection with property line, at right angles to the building, measured at property line (garage line included if applicable).

Example: "3.70 WEPL"

- Depth at property line - vertical distance (depth) at property line from ground surface to top of sewer connection.

5.2.3 Point of intersection at building

- Short measurement - distance from most effective building line to point of intersection of sewer connection with building line, measured at building line. (Garage line included if applicable).

Example: "2.40 EWBL"

- Depth at building line - vertical distance (depth) at building line from ground surface to top of sewer connection.

5.2.4 Fittings (Bends, Wye)

- Measurement- distance from main sewer or point of intersection at property line or at point of intersection at building line (whichever is more effective/applicable), to the fitting, measured along the line of the sewer connection.

Example: "1.2 N SM' (where "SM'" stands for sewer main)

Or: "1.4 S PROPERTY LINE" or "PL" for property line

Or: "35 N BUILDING" or "BLDG" for building

5.2.5 Standpipe

- Measurement - horizontal distance from main sewer to the stand pipe, measured along the line of sewer connection. Note: some standpipes will be in the same horizontal position as the junction.

Example: "0.5 N of SM" (where "SM" stands for sewer main or from JCT where "JCT" stands for junction).

- Depth at standpipe - vertical distance (depth) at standpipe from ground surface to top of standpipe,

Example: "2.4"

Additional comments:

- Any measurement describing a point from and to, shall be in terms of North, South, East, or West, as opposed to Left and Right
- No measurements shall be taken from valves or hydrants for curb stops or corporation stops
- There is an understanding that after taking all applicable measurements and plotting the true position of each feature by its XY coordinates, there will be less of a need to rely on traditional descriptions versus the ability to see these things visually in their true form in relation to other features

Example of Building Sewer Service Record



Water and Waste Department • Service des Eaux et des Déchets

BUILDING SERVICE RECORD

Address: -
Date Installed: - Inspected By -
Nature of Service:

WATER SERVICE

Street Serviced from:
Position of SC:

Position of CC:

Distance SC to Bldg – N/A
Distance Main - SC
Depth of Main
Depth of Property Line NA
Connected To:
Coupling Location –
Reversed Tapped: -
Continuity Bonding: -
Anodes: -
Water Comments:

Materials
SIZE
CORP
CSTOP -

Pipe Material:

WASTE WATER SERVICE

Street Serviced from: -
Junction Location @ Main: -
Service Location @ Prop. -

Service Size: -

Materials --
BLDG Line Meas:
Standpipe Meas:
Fittings Measurements: -
Sewer Comments: -

Depth at P/L: -
Depth at Jct: -

Date Entered: -

Entered By: -
Signature:

Figure 41

6.0 REVISING A CONSTRUCTION DRAWING TO A RECORD DRAWING

It must be kept in mind from the outset that the post construction drawing shall become a valuable permanent record. With the ability to integrate CAD drawings directly into the Department's GIS, the infrastructure shown in the GIS Record Drawing, as well as the Final Record Drawing, shall be accurately represented. This shall enhance the accuracy of the water and sewer infrastructure being displayed in the GIS. It is essential that the designing agency maintains an accurate record of any changes to the design occurring during construction, and that these changes are accurately and completely recorded on the post construction drawing.

Based on the above definitions, the expectation by the WWD is that record drawings are required for all water and sewer projects.

6.1 REQUIREMENTS FOR A WATER OR SEWER RECORD DRAWING

All dimensions shown shall reflect the "as constructed" conditions of the construction and all references to "proposed" or "new" shall be removed or worded in the past tense. Record drawings shall be drawn to scale in accordance with the "as-constructed" dimensions shown. The revision block shall be completed indicating the drawings have been revised to record drawings. All displays (viewports) of the drawing shall be locked.

Line work for all constructed works shown on the drawings shall retain the thicker line density (as for proposed works) for ease of determining the extent of works covered by the drawings. Proposed construction for future phases of the project shall not be shown on the record drawings.

The record drawing shall also include the location and elevation of all existing utilities and services encountered in the construction operation.

Construction Completion Date – approximate date the project was completed. The substantial completion date is an acceptable alternative. This shall be located in the lower right portion of the plan right above the title block.

Record/As-built: once determined what the drawing is, a stamp is needed displaying either "RECORD DRAWING", or AS-BUILT".

6.1.1 Material Lists

The WWD GIS is currently being used to manage and inventory all of its underground assets. It is therefore extremely important that the materials and products used on projects be accurately listed and accounted for to facilitate entry into the GIS (See Figure 42 below).

MATERIALS LIST					
WATER					
ITEM	MANUFACTURER	MODEL	DIMENSION RATIO	PRESSURE CLASS	MATERIAL
150 WM PIPE	IPEX	BLUE BRUTE	18	235	PVC
150 FITTINGS	IPEX	BLUE BRUTE	18	235	PVC
150 COUPLINGS	ROMAC INDUSTRIES	XR501			DUCTILE IRON
400 WM PIPE	ROYAL PIPE	ROYAL SEAL	18	235	PVC
400 FITTINGS	SIGMA CORPORATION	TYTON JOINT		250	CAST IRON
400 COUPLINGS	ROBAR INDUSTRIES	1507		200	DUCTILE IRON
19 SERVICE PIPE	WOLVERINE	TYPE K		K	COPPER
19 CURB STOPS	MUELLER CANADA	H-15154			BRASS
19 CORPORATION STOPS	MUELLER CANADA	A-220			BRASS
150 GATE VALVES	MUELLER CANADA	A-2360-40			CAST IRON
400 GATE VALVES	CLOW CANADA	F-6112			CAST IRON

Figure 42

Products listed in the material list shall be described as completely as possible so as not to leave any ambiguity of what was used on the project. Only one type of material and manufacturer shall be shown on the list for any given item.

As an example:

- 150 PVC Water Main Pipe-Rehau/Ipex - shall not be used.
- 150 PVC Water Main Pipe-Rehau - **shall be used**

The specific instances of the other product(s) shall be noted on the plan portion of the drawing.

For a complete listing of up-to-date approved products for underground use in the City of Winnipeg please visit:
http://winnipeg.ca/finance/findata/matmgt/std_const_spec/current/Docs/Approved_Products_Underground_Works.PDF

6.1.2 GIS Requirements

This section makes mention of some data that historically has not been provided on record drawings but is necessary to update the GIS.

MATERIALS LIST					
CIPP LINING					
ITEM	MANUFACTURER	MODEL	DIMENSION RATIO	PRESSURE CLASS	MATERIAL
TUBE	APPLIED FELTS				POLYURETHANE COATED FELT
RESIN	INTERPLASTIC CORPORATION	COR72-AT-470			POLYESTER

Figure 43

6.1.3 AUGMENTED (Combination of Complete Relining with EPR)

For Augmented Lining projects the record drawings shall include:

- The location of all junctions that were reinstated
- Invert elevations at the new pipe section ends
- What connectors were used at the pipe connection ends, e.g. adapter or coupling
- Updated sewer table with new inspection
- Type of liner used and Manufacturer
- Liner Example: Coated Felt Inversion Liner
- Manufacturer Example: Applied Felts
- Type of Resin used and the Manufacturer
- Resin Example: Polyester
- Manufacturer Example: Alpha Owens Corning (AOC)
-
- Liner Thickness
Example: 4.5 mm

6.1.4 CIPP Lining

For CIPP lining projects the record drawings shall include:

- Type of liner used and Manufacturer
Liner Example: Coated Felt Inversion
Manufacturer Example: Liner Applied Felts
- Type of Resin used and the Manufacturer
Resin Example: Polyester
Manufacturer Example: Alpha Owens Corning (AOC)
- Liner Thickness
Example: 4.5 mm

6.1.5 External Point Repairs (SD-022A and SD-022B)

For External Point Repair projects, the record drawings shall include:

- SD-022A is comprised of a length 3.0m or less, SD-022B is comprised of a length of 3.1m or greater
- All junction locations within the repaired pipe and if possible the street address of the affected services
- Invert elevations at the new pipe section ends
- What connectors were used at the pipe section ends, e.g. an adapter or coupling
- Updated sewer table with new inspection

6.1.6 Internal Point Repairs (TPR's or Trenchless Point Repairs)

For this work the record drawings shall include:

- The location of the lining clearly defined
- The location of all junctions that were reinstated and if possible the street address of the affected service
- Type of liner used and Manufacturer
Liner Example: Coated Felt Inversion
Manufacturer Example: Liner Applied Felts
- Type of Resin used and the Manufacturer
Resin Example: Polyester
Manufacturer Example: Alpha Owens Corning (AOC)
- Liner Thickness
Example: 4.5 mm
- Updated sewer table with new inspection

6.1.7 Sewer Main Renewal

For sewer main renewal projects, the plan portion shall include:

- Property address of any sewer services that have been renewed, with updated table
- Property line measurement for any sewer services that have been renewed
- Sewer televising table shall be removed from the final drawings
- Drawings shall not contain any "Future Works"
- All new inverts/elevations shall be to three significant figures
- All abandoned features shall be on the appropriate layers and blocks
- Sewer service table reference and/or materials list note shall be shown if located on different drawing
- All drawings shall have a materials list, and service table shall be unique to the drawing
- All drawings shall have directional flow arrows on plan view and profile
- All abandoned features shall be incorporated on plan and profile. They will be used with the existing abandoned layers (E_WATER_PROFILE_ABAND, E_WATER_ABAND_PLAN. Also see APPENDIX N (CONT) Symbol List Part 3 for block

6.1.8 Ditch Work or 'Open Channel'

For work that involves ditching, record drawings shall include:

- X-section(s) for the earth work wherever there is a change to the x-section e.g., a change to the bottom width or side slope
- Elevation and chainages for the start and end of culverts
- Elevations of the ditch at the high and low points
- Diameter and manufacturer of any corrugated metal piping (CMP)
- Type of grating (if applicable) and grate spacing
- Identify rip-rap pads (if applicable)
- All drawings shall have directional flow arrows on plan view and profile
- Flow arrow for any overland water flow on the plan shall be provided

6.1.9 Water Main Renewal

For water main renewal projects, the plan portion shall include:

- Property address of any water services that have been renewed, with updated table (this table shall not contain asterisks)
- Long measurements shall be to two decimal places
- Property line measurement for any water services that have been renewed
- Drawings shall not contain any "Future Works"
- All new inverts/elevations shall be to three significant figures
- All text shall be masked
- All abandoned features shall be on the appropriate layers and blocks
- Water service table reference and/or material list if at all possible shall be on the drawing the information pertains too but if this is not achievable a note shall be shown indicating where they are located. Additionally, if the materials list must be located on another drawing the drawing numbers shall be listed in the heading of the list
- All abandoned features shall be incorporated on plan and profile. They will be used with the existing abandoned layers (E_SEWER_PROFILE_ABAND, E_SEWER_ABAND_PLAN. Also see APPENDIX N (CONT) Symbol List Part 3 for block
- If possible, the materials list shall be unique to the drawing
- Elevations shall be labeled where ever the grade changes, or at any tee/cross

6.2 FINAL RECORD DRAWING EXAMPLES

Oversize ISO A1 (594 mm x 841 mm) Plan/Profile Record Drawing Water

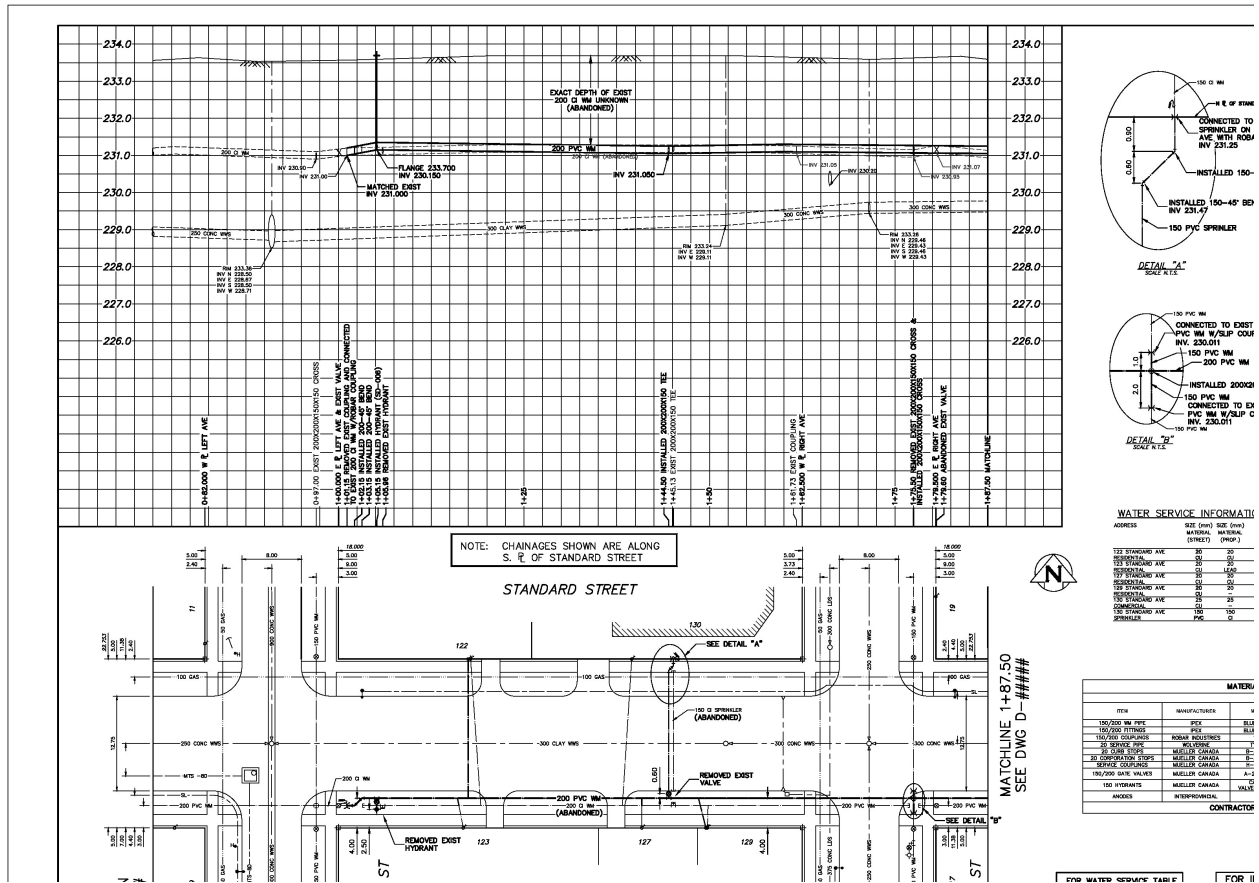

Figure 44
(For a larger view see Appendix R)

6.2.1 Overseize ISO A1 (594 mm x 841 mm) Plan/Profile Record Drawing – Sewer

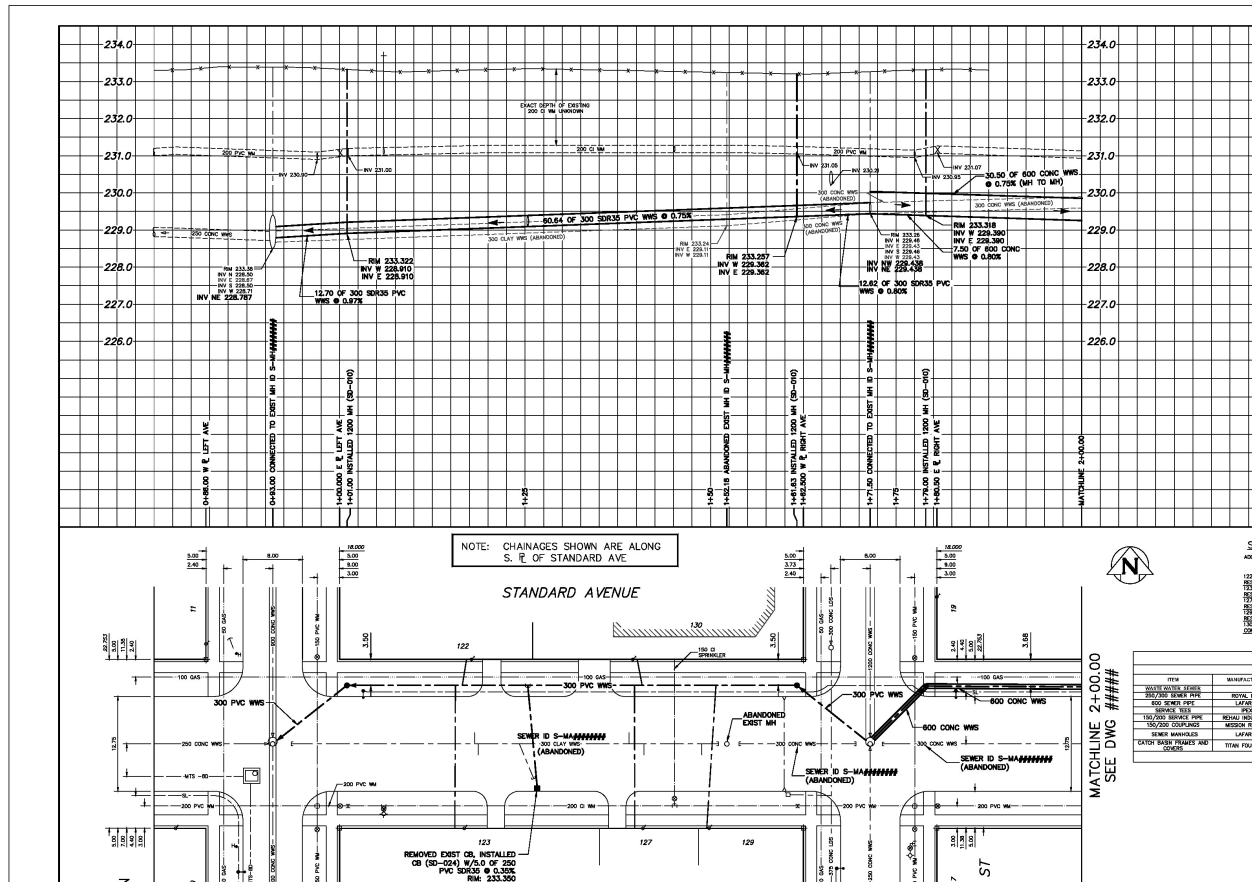

Figure 45
(For a larger view see Appendix S)

6.2.2 Overse ISO A1 (594 mm x 841 mm) Plan/Profile Record Drawing – Open Channel (Ditching)

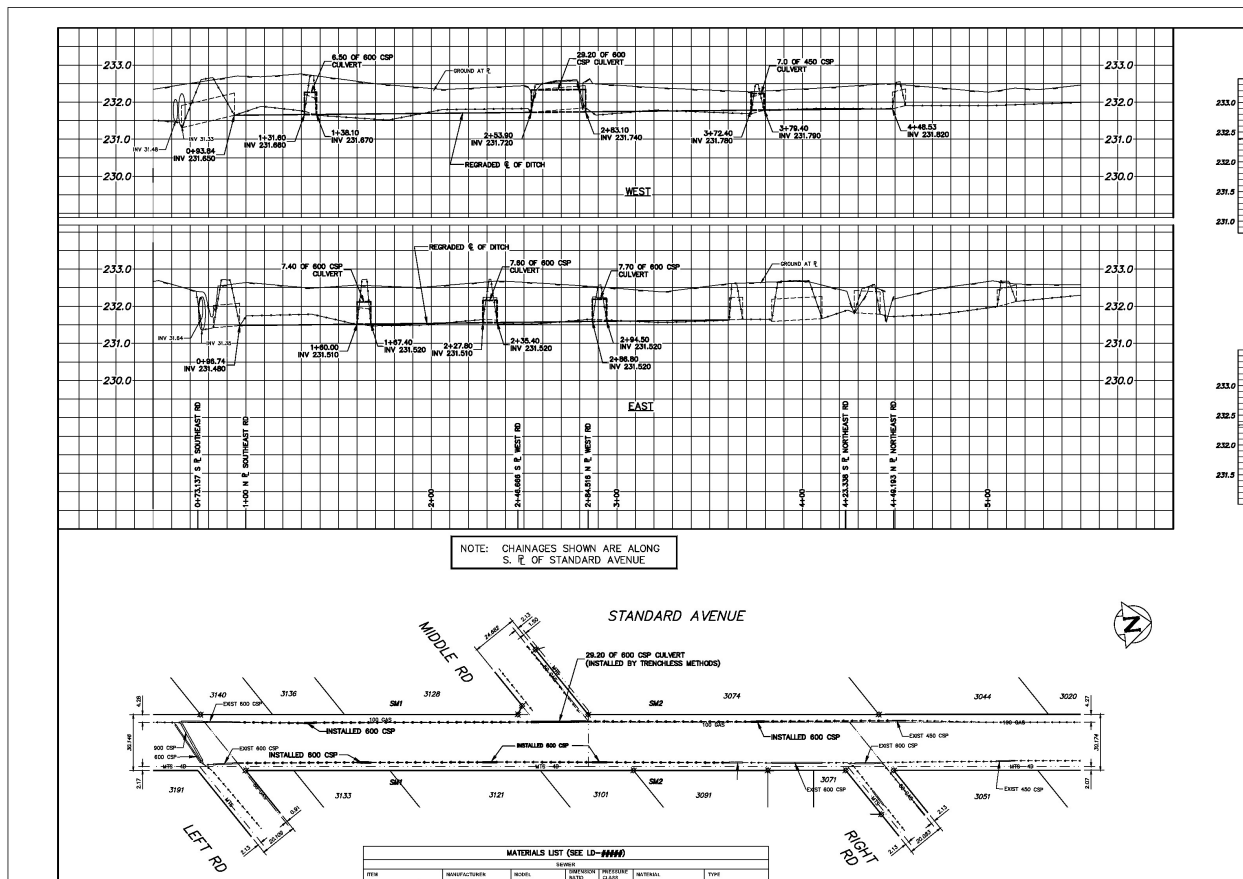

Figure 46
(For a larger view see Appendix T)

6.2.3 11" x 17" Sewer Sheet Record Drawings

11" x 17" Sewer Renewal by CIPP Lining Record Drawing

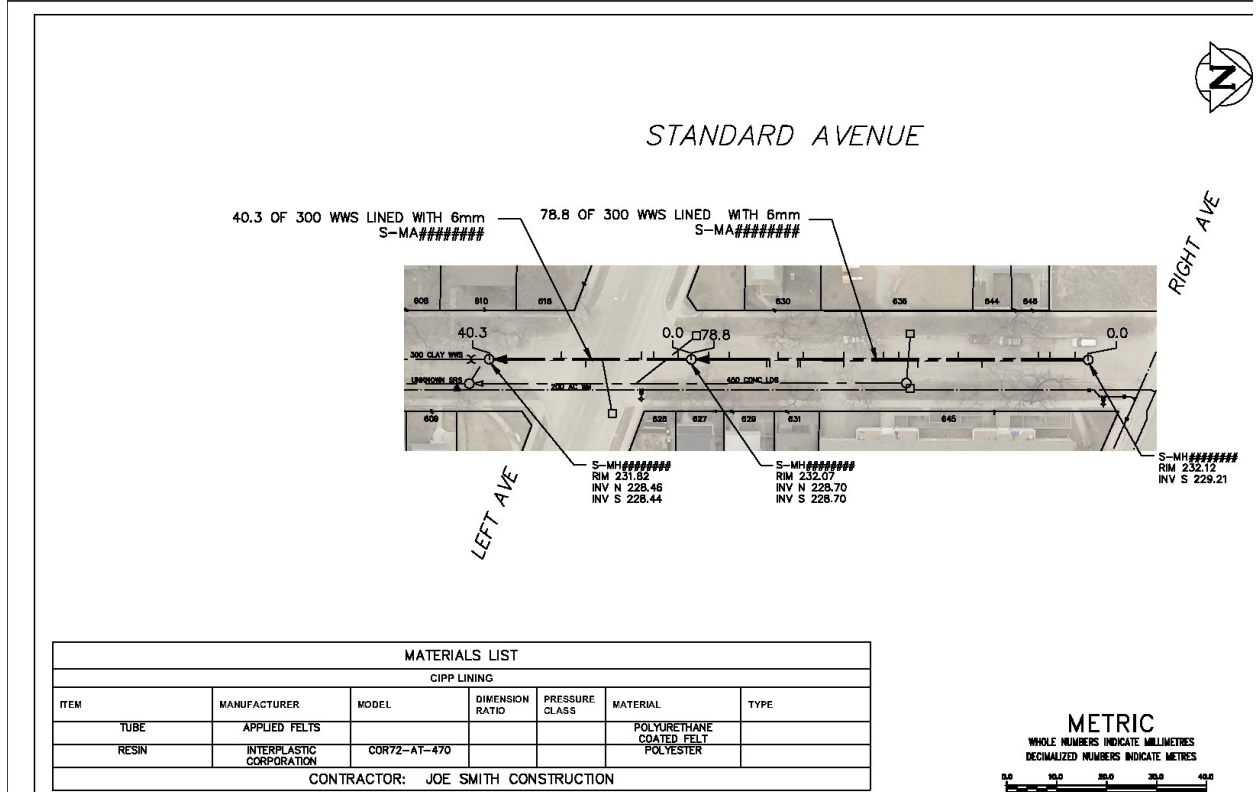

Figure 47
(For a larger view see Appendix U)

6.2.4 11" x 17" External Point Repair (EPR) and Trenchless Point Repair (TPR) Record Drawing

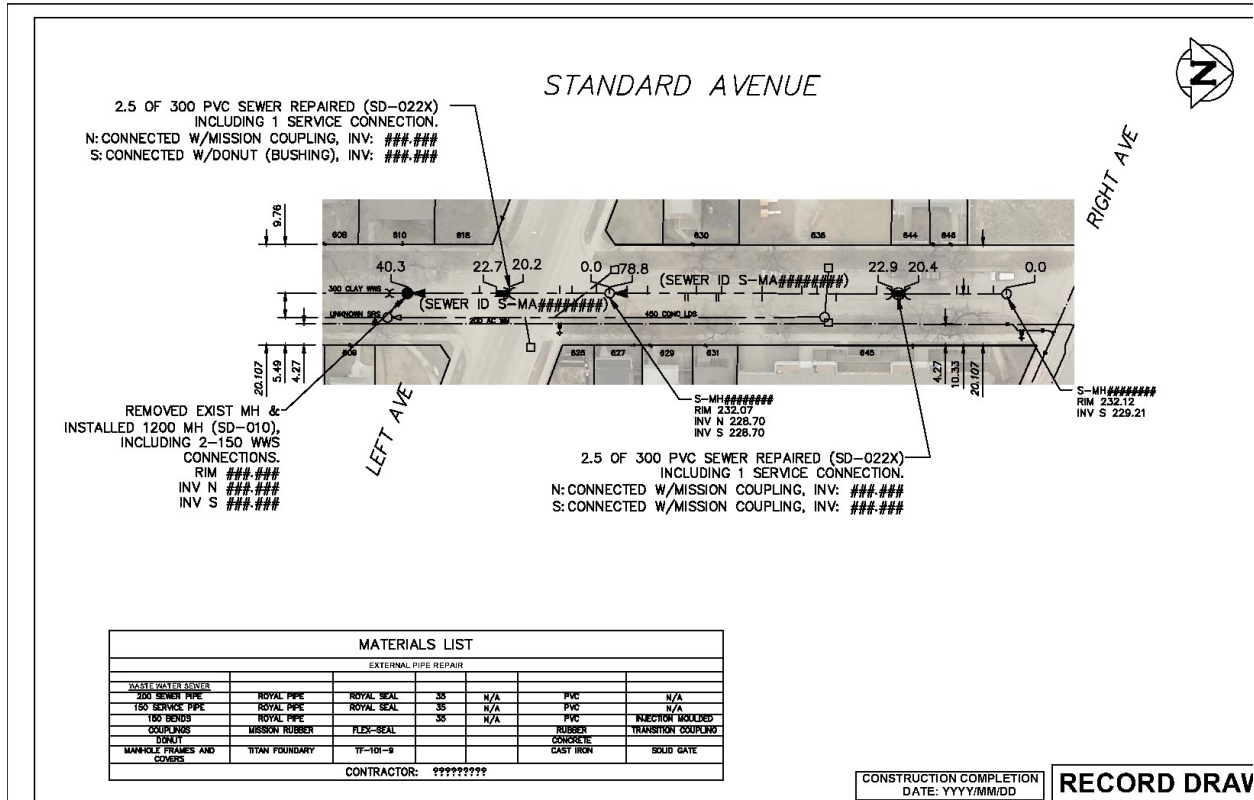

Figure 48
(For a larger view see Appendix V)

6.2.5 11" x 17" Augmented Lining Record Drawing

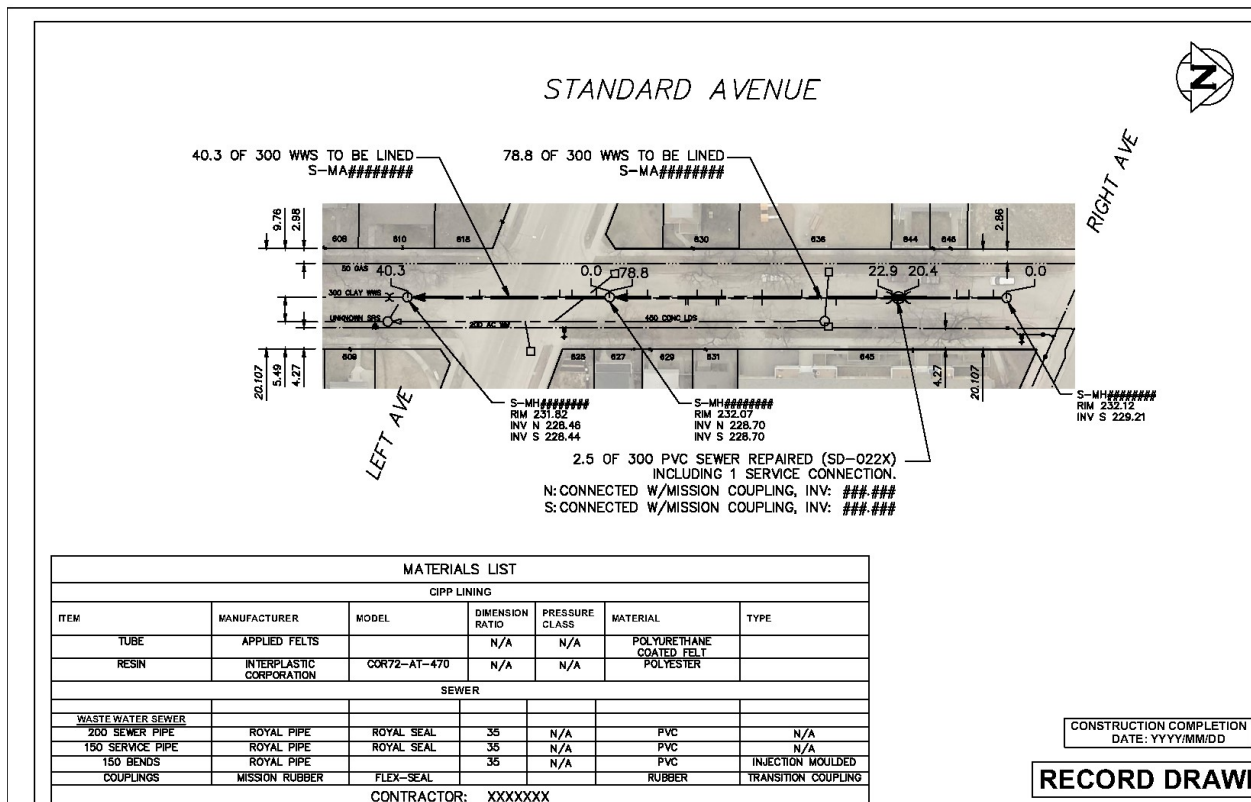

Figure 49
(For a larger view see Appendix W)

6.3 FINAL GIS DRAWING EXAMPLES

No layout is required for these drawings shown in model space view below. For the included layers Please see section 4.0 Layers Required in The Final GIS Drawing

Where possible, one drawing file shall be submitted. This drawing file shall encompass the entire project in model space (see Figure 50 below).



Figure 50

6.3.1 Upsize ISO A1 (594 mm x 841 mm) GIS Record Drawing Water

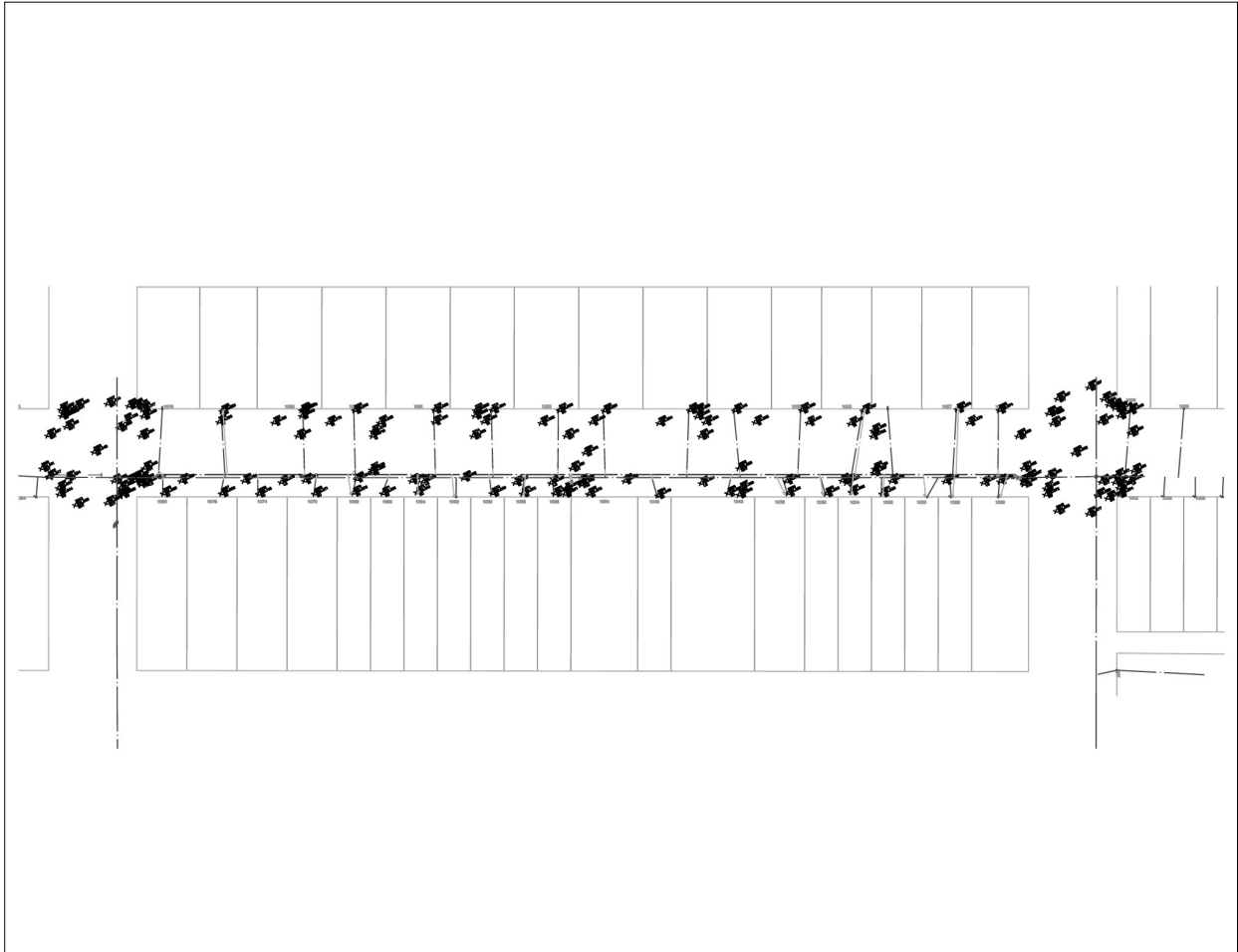

Figure 51
(For a larger view see Appendix X)

6.3.2 Oversize ISO A1 (594 mm x 841 mm) GIS Record Drawing Open Channel (Ditching)

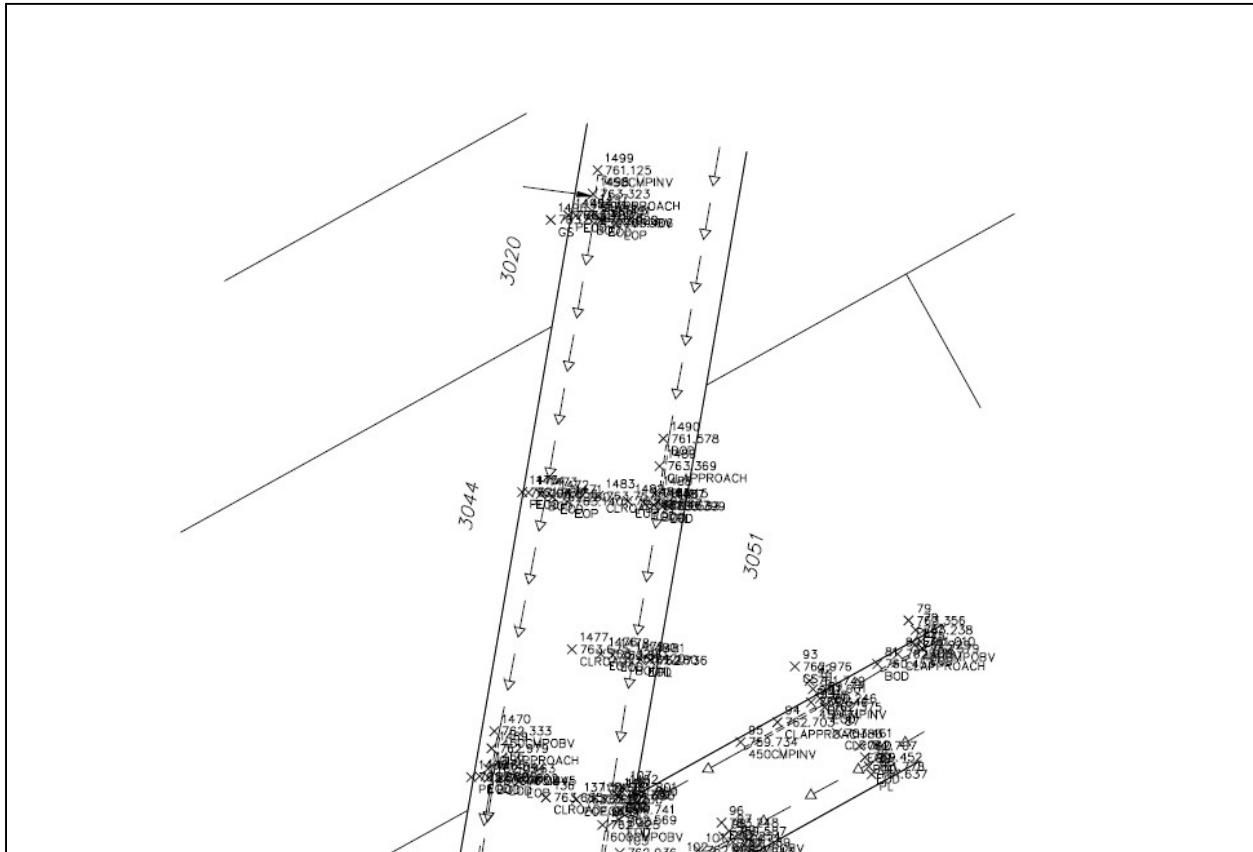

Figure 52
(For a larger view see Appendix Y)

7.0 SUBMITTING A RECORD DRAWING TO THE WWD

The procedure for submitting record drawings to the WWD is as follows:

7.1 PRELIMINARY REVIEW

Full size PDF files of the completed record drawings, plotted to scale, shall be submitted to the WWD for review prior to the submission of the final record drawings.

11x17 Drawings shall be accompanied by the AutoCAD drawing files.

The PDF files and AutoCAD drawing files (if applicable) shall be sent to the WWD attention,

**The Supervisor, Drafting and Graphic Services
Engineering Division
Water and Waste Department
110-1199 Pacific Avenue
Winnipeg MB, R3E 3S8**

The WWD will review the PDF drawings for errors and or omissions. The "marked up" drawings, with comments shall be returned to the submitting organization under instructions to revise the record drawings according to the changes indicated on the PDF drawing.

The revised or 'final' drawings (please see below), will be proofed to ensure any requested changes have been completed to the satisfaction of the WWD. Drawings not completed to the satisfaction of the WWD shall be returned to the submitting organization for correction.

7.2 FINAL REVIEW

Once the preliminary record drawings have been revised, the Final Record drawings shall be provided as PDF files, unless the contract specifies the requirement for Mylar copies. The final drawings shall be stamped and signed by a professional engineer prior to submitting the drawings to the WWD. An AutoCAD file (dwg), a PDF file, and a full size paper copy for each individual record drawing is required.

7.3 DIGITAL FILES

1. Final GIS Drawing files provided to the Department shall be produced in AutoCAD, or Civil 3D, and saved in the version presently being used by the WWD. Third party fonts, hatch patterns, custom line types or shapefiles, shall not be used in final GIS Drawing files.
2. Drawing files shall be submitted on CD/DVD, USB storage device, or made available on an FTP site.
3. Each individual Final Record Drawing that is part of an overall project package must be submitted to the WWD as individual drawing files, using the Department assigned drawing number as the file name, e.g. D-#####.dwg. **In the case of the Final GIS Drawings, where at all possible, one drawing file shall be submitted. This one drawing file shall encompass the entire project in model space.**

4. On large projects, where several drawings are needed to show continuous infrastructure, the base entities and cadastral data shall be continuous in model space. These entities shall not be "broken up," rotated or edited in order to depict the specific sections of the project on individual drawings. Only views, paper space and layouts shall be used to display the work.
5. All Final Record Drawing and Final GIS Drawing files shall have all tabs and model space zoomed to EXTENTS, prior to any submittal to the WWD, whether it is the final or a working submittal. This is to ensure that there are no extraneous entities in the drawing.
6. All final Record Drawing files shall be saved with the first layout tab active.
7. **All final files (of both final record and final GIS drawings) shall be fully purged prior to submittal.**

8.0 FAQ

1. **Question:** We have established workflows that adhere to the City 'Bluebook' manual and we have been using these for years to produce drawings for the WWD. Will we now have to completely re-engineer our process to produce a CAD drawing?

Answer: Hopefully this will not be the case. If the look of a typical drawing that was submitted was acceptable before implementation of these standards, chances are it will still be acceptable now. Minor enhancements such as Material list shall be required.

The significant difference that this manual contains is the requirement of a second final drawing to be submitted. The entities in this drawing will become GIS objects. This drawing has an absolute minimum of WWD designated layers and symbols and may be generated however the Consultant/Design Office wishes.

Having said that, the original City 'Bluebook' manual was written, and then subsequently updated, in eras that did not have the capacity for computer assisted drafting. The basic principles within that document are still sound, however an update to the processes used to produce drawings was needed.

9.0 SUMMARY - CHECKLIST



1. All renewal projects for WWD shall be prepared using these standards and, where applicable, using the prototype drawing files, symbols, and layering conventions supplied by the Department.
2. The Final GIS drawings shall be prepared using AutoCAD or AutoCAD LT and saved in the file format for the version of AutoCAD currently used by the Department.
3. The Department shall supply cadastral and existing water/sewer network data, exported from the Department's GIS, to be used in the production of base information for a design project. Once incorporated into the drawing this data shall not be spatially moved.
4. Layers and symbols as described for the Final GIS Drawing shall not be edited and blocks must not be exploded.
5. The Final GIS drawings shall have the coordinate system set to NAD 83 June 1990 Zone 14 North and the view set to WORLD UCS.
6. All linear features depicting sewer lines in CAD drawings shall be drawn in the direction of flow for that entity, high elevation to low.
7. All drawing sets must start with a Title/Cover drawing, followed by a Legend/Drawing Index drawing.
8. All design drawings submitted to the Department must be stamped with the signed and dated seal of a professional engineer, signed and dated.
9. With the exception of aerial photography, AutoCAD drawing files submitted to the Department must not contain x-references and image attachments.
10. Upon completion of construction, the design drawings shall be revised to reflect all changes that occurred during construction.
11. The CAD drawing files shall be purged prior to submission to the WWD.
12. Drawings revised to reflect construction conditions shall be referred to, and labeled as RECORD DRAWINGS.
13. Full size paper prints of the completed record drawings, plotted to scale shall be submitted to the Department for review prior to the submission of the final record drawings. The paper prints shall be accompanied with the AutoCAD drawing files.
14. Upon completion of the review of the preliminary record drawings, the final record drawings shall be provided as a PDF file, stamped and signed by a professional engineer. The final drawing submission shall contain:
 1. A Final GIS Drawing CAD file
 2. A Final Record Drawing CAD file
 3. A PDF file of the Final Record Drawing
15. Preliminary record drawings and final drawings must be submitted to:

**The Supervisor, Drafting and Graphic Services
Engineering Division
Water and Waste Department
110-1199 Pacific Avenue
Winnipeg, Manitoba
R3E 3S8**
16. With the exception of GIS Record Drawings, the various drawings that comprise a set of drawings must be saved as individual digital drawing files. The City of Winnipeg WWD supplied drawing number shall be used as the file name for the digital drawing.

10.0 APPENDIX

APPENDIX A - TITLE/COVER SHEET - TITLE/COVER SHEET
(A1)

Oversize ISO A1 (594 mm x 841 mm) Landscape Title/Cover Sheet

	<p>THE CITY OF WINNIPEG WATER AND WASTE DEPARTMENT ENGINEERING DIVISION</p> <p>20## WATER MAIN RENEWALS & ASSOCIATED WORKS</p>	<p>CONTRACT NO. # TENDER: ##-##-##</p>		<p>KEY MAP</p>	<p>DATE: 11/11/11 CITY DRAWING NUMBER: D-####</p>
---	--	--	---	----------------	---

APPENDIX B- TITLE/COVER SHEET (11X17)

11"x 17" Title/Cover Sheet



THE CITY OF WINNIPEG

WATER AND WASTE DEPARTMENT

ENGINEERING DIVISION

20## SEWER RENEWALS BY CIPP LINING

CONTRACT NO: #
TENDER: ##-##-####

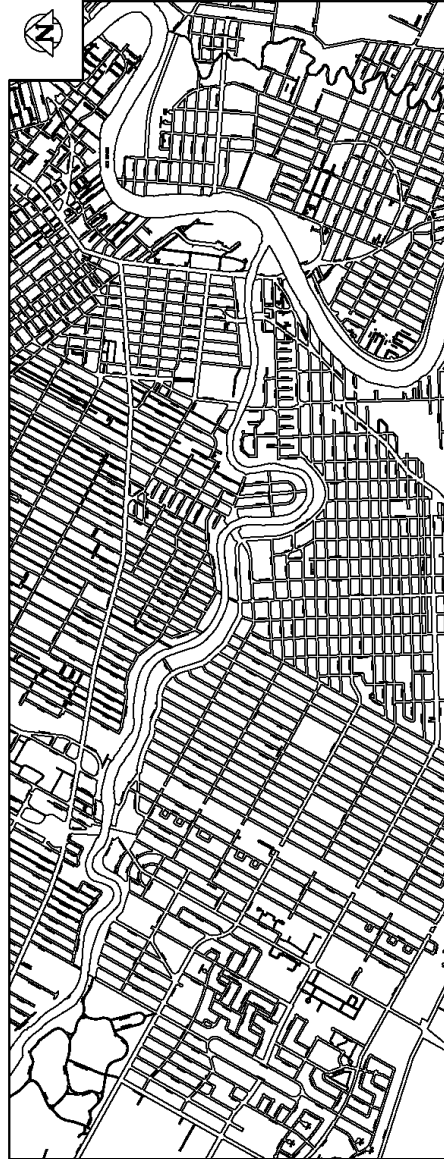

KEY MAP

SHEET #	OF #
CITY DRAWING NUMBER	#####

FILE PATH: \\WINNIPEG\CAD\GIS\Drawings\General\Drawing\Waste\Water\20##\20##.DWG
FILE NAME: 20##_1117_1.dwg

APPENDIX D - SEWER INDEX CONSTRUCTION DRAWING (A1)

Upsize ISO A1 (594 mm x 841 mm) Sewer Legend/Drawing Index Sheet (Construction Dwg)

<p>DRAWING INDEX</p> <p>CITY OF WINNIPEG DRAWING NUMBER</p> <p>CITY SHEET #</p>	<p>DRAWING TITLE</p> <p>OVERLAP PAGE</p> <p>DRAINAGE INDEX, DESIGN MATRIX, LEGEND, & ABBREVIATIONS</p>	<p>ABBREVIATIONS</p> <p>WWS - WASTE WATER SERVICES S - SANITATION E - ELECTRICAL L - LANDSCAPE T - TRAFFIC S - SEWER M - MAIN M - MANHOLE W - WATER T - TRUNK S - STREET R - ROAD C - CURB P - PAVEMENT S - SIDEWALK S - STREET LIGHT S - STREET LIGHT FOUNDATION S - STREET LIGHT COLUMN S - STREET LIGHT ARM S - STREET LIGHT FIXTURE S - STREET LIGHT BRACKET S - STREET LIGHT BASE S - STREET LIGHT POST S - STREET LIGHT FOUNDATION S - STREET LIGHT COLUMN S - STREET LIGHT ARM S - STREET LIGHT FIXTURE S - STREET LIGHT BRACKET S - STREET LIGHT BASE S - STREET LIGHT POST</p>	<p>LEGEND</p> <p>PLAN VIEW</p> <p>ADVANCED</p> <p>EXTEND</p> <p>PROPOSED</p>
<p>HATCH PATTERNS</p> <p>LAYERS OR GROUND ABOVE PIPE</p> <p>SLAB OR OTHER FINE MATERIAL</p> <p>CONCRETE</p> <p>WASHED STONE OR GRANULAR MATERIAL</p> <p>INTERLOCKING STONE</p> <p>METAL</p> <p>GRAVEL OR STONE</p>	<p>CONSTRUCTION NOTES</p> <p>1. ALL PIPE SHALL HAVE CLASS B - TYPE 1 BEDDING</p> <p>2. INSTALL SEWER BY TRENCHLESS METHOD</p> <p>3. CONFIRM THE LOCATION OF ALL SEWER SERVICES</p> <p>4. BURLAP UNDOY FASCIN, IN SECTIONS, & WITHIN 1.0 OF FASCIN TO BE CLASS 1</p> <p>5. BURLAP IN BELLOWS TO BE CLASS 1</p> <p>6. MINOR SEWER SERVICES TO 'C'</p> <p>7. INSTALL SEWER SERVICE RISERS TO ELEVATION WHERE MINIMUM SLOPE OF 1% IS MAINTAINED FOR ALL SERVICES</p>	<p>PROFILE</p> <p>ALLOWED</p> <p>EXTEND</p> <p>PROPOSED</p>	<p>THE CITY OF WINNIPEG WATER AND WASTE DEPARTMENT ENGINEERING SERVICES DIVISION</p> <p>201# SEWER MAIN RENEWALS CONTRACT #</p> <p>INDEX PAGE</p> <p>SHEET # OF #</p> <p>#####</p>

APPENDIX E - SEWER INDEX CONSTRUCTION DRAWING (11X17)

11" x 17" Sewer Legend/Drawing Index Sheet (Construction Dwg)

DRAWING INDEX		DRAWING TITLE		LEGEND		PLAN VIEW		CONTRACT INFORMATION	
SHEET NUMBER	CITY OF WINNIPEG DRAWING NUMBER	COVER PAGE	DRAWING INDEX, DESIGN NOTES, LEGENDS & ABBREVIATIONS	DESCRIPTION	ABBREVIATED	EXISTING	PROPOSED	20## SEWER RENEWALS BY CPP LINING	SHEET # OF # CITY DRAWING NUMBER
1	#####							CONTRACT #	#####
2	#####							INDEX PAGE	
3	#####								
4	#####								
5	#####								
6	#####								
7	#####								
8	#####								
9	#####								
10	#####								
11	#####								
12	#####								
13	#####								
14	#####								
15	#####								
16	#####								
17	#####								
18	#####								
19	#####								
20	#####								
21	#####								
22	#####								
23	#####								
24	#####								
25	#####								
26	#####								
27	#####								
28	#####								
29	#####								
30	#####								
31	#####								
32	#####								
33	#####								
34	#####								
35	#####								
36	#####								
37	#####								
38	#####								
39	#####								
40	#####								
41	#####								

ABBREVIATIONS

11" x 17" Sewer Legend/Drawing Index Sheet (Construction Dwg)

CONSTRUCTION NOTES

1. ALL PIPE SHALL HAVE CLASS B - TYPE 2 ENDING
2. INSTALL SEWER BY TRENCHLESS METHODS.
3. CONFIRM THE LOCATION OF ALL SEWER SERVICES.
4. BACKFILL UNDER PAVEMENT, IN SIDEWALKS, & WITHIN 1.0 OF PAVEMENT TO BE CLASS 3.
5. BACKFILL IN BOWLELAND TO BE CLASS 3.
6. REPAIR SEWER SERVICES TO 1.
7. INSTALL SEWER SERVICE RISERS TO ELEVATION WHERE MINIMUM SLOPE OF 1% IS MAINTAINED FOR ALL SERVICES.

HATCH PATTERNS

DRAWING INDEX

SHEET NUMBER: 1

CITY OF WINNIPEG DRAWING NUMBER: #####

LEGEND

PLAN VIEW

DESCRIPTION	ABBREVIATED	EXISTING	PROPOSED
11" x 17" Sewer Legend/Drawing Index Sheet (Construction Dwg)

THE CITY OF WINNIPEG

WATER AND WASTE DEPARTMENT

ENGINEERING DIVISION

20## SEWER RENEWALS BY CPP LINING

CONTRACT #

SHEET # OF # CITY DRAWING NUMBER

INDEX PAGE

APPENDIX G - SEWER CONSTRUCTION DRAWING (A1)

Oversize ISO A1 (594 mm x 841 mm) Plan/Profile Sheet – Sewer (Construction Dwg)

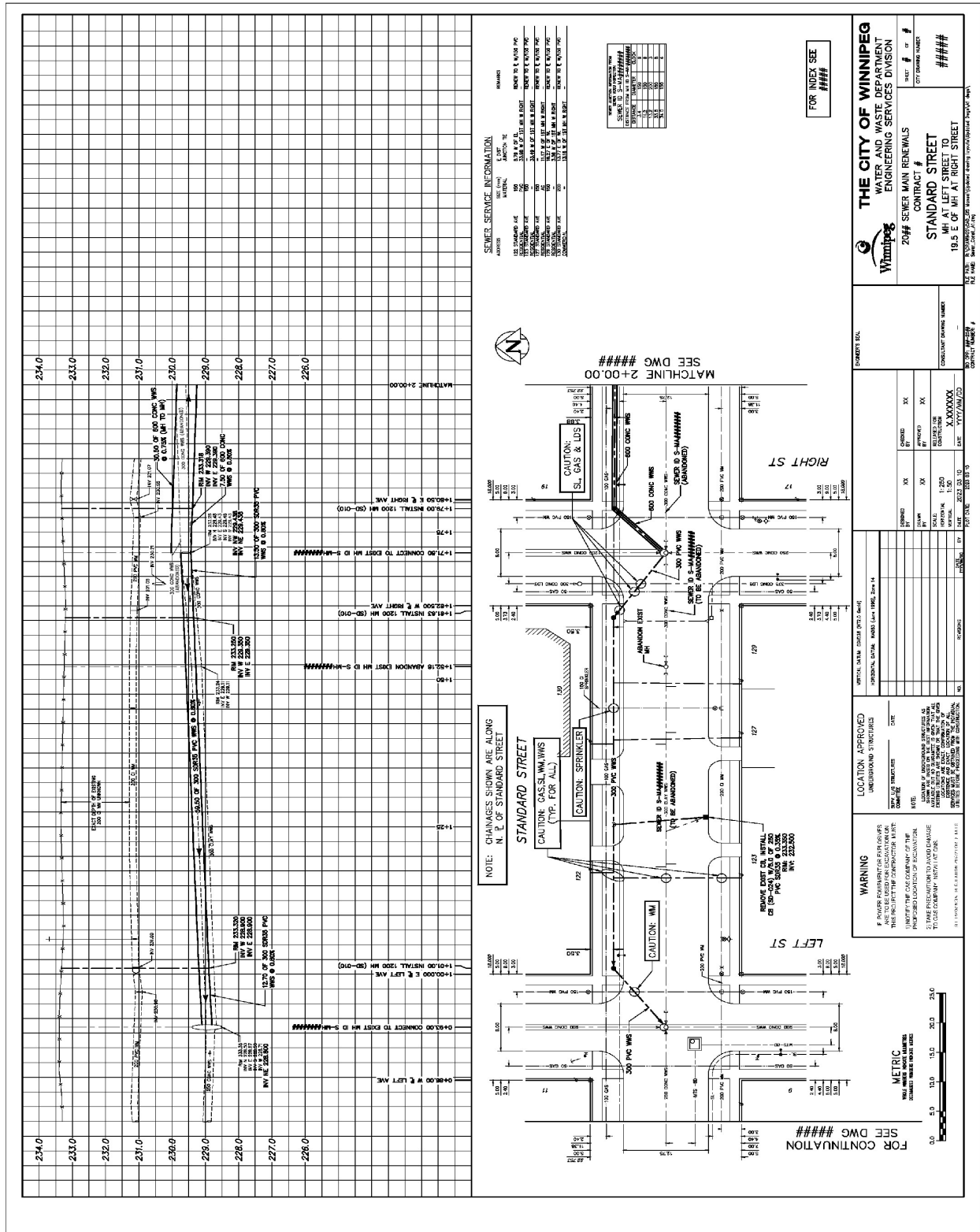

APPENDIX H - OPEN CHANNEL CONSTRUCTION DRAWING (A1)

Oversize ISO A1 (594 mm x 841 mm) Plan/Profile Sheet – Open Channel (Ditching) (Construction Dwg)

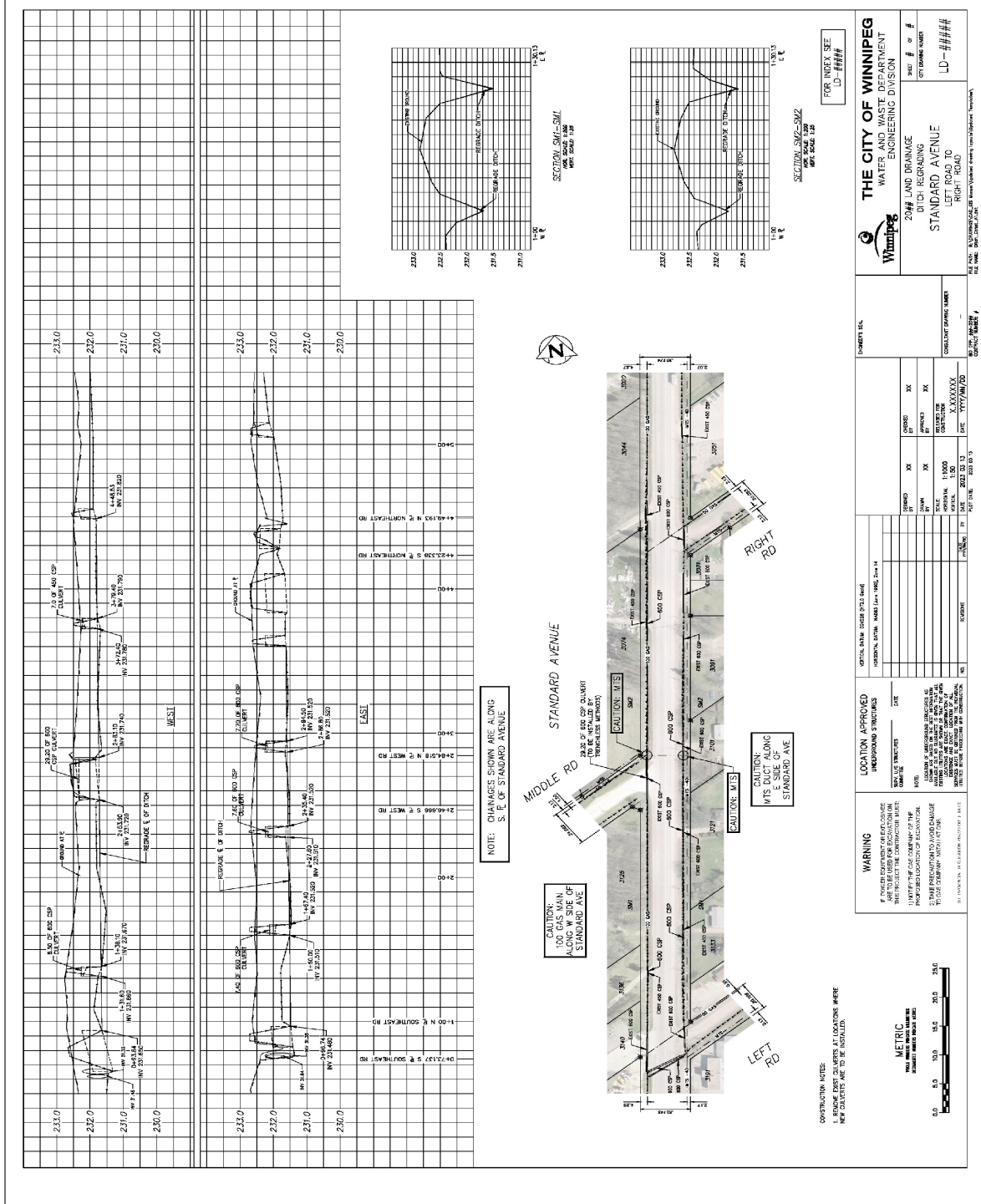

THE CITY OF WINNIPEG
WATER AND WASTE DEPARTMENT
ENGINEERING DIVISION

20# LAND DRAINAGE
DITCH REGRADING
STANDARD AVENUE
LEFT ROAD TO
RIGHT ROAD

PROJECT # / SHEET # OF #
LD-####

DATE: 2023.03.13
SCALE: 1:500
DRAWN: [Name]

NO.	REVISION	DATE	BY	CHK
1	ISSUED FOR PERMIT	2023.03.13	[Name]	[Name]
2	FOR CONSTRUCTION	2023.03.13	[Name]	[Name]

NO.	REVISION	DATE	BY	CHK
1	ISSUED FOR PERMIT	2023.03.13	[Name]	[Name]
2	FOR CONSTRUCTION	2023.03.13	[Name]	[Name]

WARNING
THIS DRAWING IS THE PROPERTY OF THE CITY OF WINNIPEG. IT IS TO BE USED ONLY FOR THE PROJECT AND LOCATION SPECIFICALLY IDENTIFIED HEREON. IT IS NOT TO BE REPRODUCED, COPIED, OR TRANSMITTED IN ANY FORM OR BY ANY MEANS, ELECTRONIC OR MECHANICAL, INCLUDING PHOTOCOPYING, RECORDING, OR BY ANY INFORMATION STORAGE AND RETRIEVAL SYSTEM, WITHOUT THE WRITTEN PERMISSION OF THE CITY OF WINNIPEG.

LOCATION APPROVED
UNCONFINED STRUCTURES

CONTRACT NUMBER / **DATE**

APPENDIX I - CIPP CONSTRUCTION DRAWING (11X17)

11" x 17" Sewer Renewal by CIPP Lining (Construction Dwg)

SEWER JUNCTION INFORMATION FROM SEWER VIDEO INSPECTION		
SEWER ID	S-MA#####	CLOCK
DISTANCE FROM MH ID <td>S-MH#####</td> <td></td>	S-MH#####	
2.8	150	2
7.8	150	2
10.0	150	2
21.2	150	10
26.0	150	2

SEWER JUNCTION INFORMATION FROM SEWER VIDEO INSPECTION		
SEWER ID	S-MA#####	CLOCK
DISTANCE FROM MH ID <td>S-MH#####</td> <td></td>	S-MH#####	
2.8	150	2
7.8	150	2
10.0	150	2
21.2	150	10
26.0	150	2
34.1	150	10
37.9	150	2
41.0	150	2
48.0	150	11
57.0	150	2
57.8	150	10
58.1	150	10
62.0	150	1
63.7	150	11
64.3	150	10
71.8	150	2
73.7	150	10
76.0	150	2

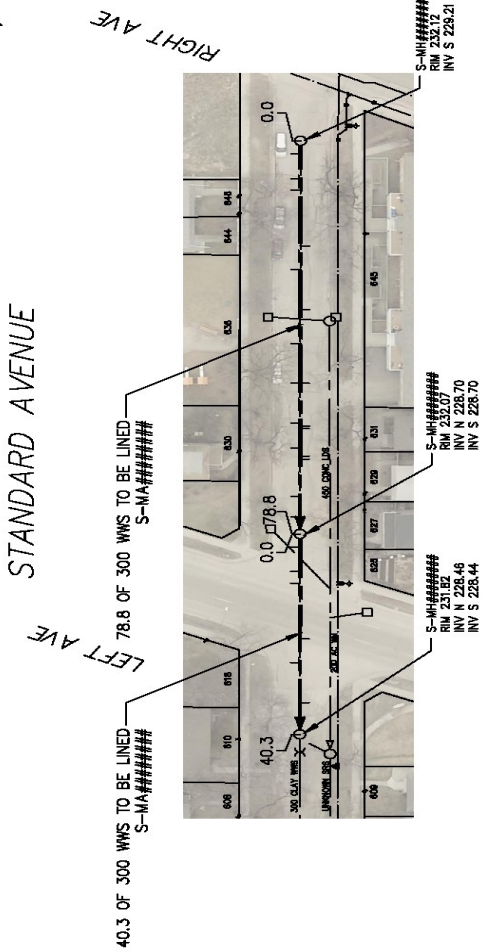

FOR INDEX SEE SHEET #####

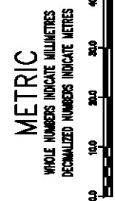

WARNING
 IF POWER EQUIPMENT OR EXPLOSIVES ARE USED IN THE VICINITY OF UNDERGROUND UTILITIES, THIS PROJECT THE CONTRACTOR MUST:
 1) NOTIFY THE GAS COMPANY OF THE PROPOSED LOCATION OF EXCAVATION.
 2) TAKE PRECAUTION TO AVOID DAMAGE TO GAS COMPANY INSTALLATIONS.
 SEE PROVINCIAL REGULATION 1017 FOR DETAILS

THE CITY OF WINNIPEG WATER AND WASTE DEPARTMENT ENGINEERING DIVISION		SHEET # OF # CITY DRAWING NUMBER #####	
20## SEWER MAIN RENEWALS BY CIPP LINING STANDARD AVENUE 1ST MH S OF RIGHT AVENUE 1ST MH S OF LEFT AVENUE		FILE NAME: B:\WINNIPEG\CAD\Bios\Approved\main\11x17\11x17.dwg FILE DATE: 2023-03-10	
DRAWN BY: [] CHECKED BY: [] DATE: 2023-03-10		CONTRACT NUMBER: [] DATE: 2023-03-10	
LOCATION APPROVED UNDERGROUND STRUCTURES		REVISIONS: []	

APPENDIX J - EPR/TPR CONSTRUCTION DRAWING (11X17)

11" x 17" External Point Repair (EPR) and Trenchless Point Repair (TPR) Sheets (Construction Dwg)

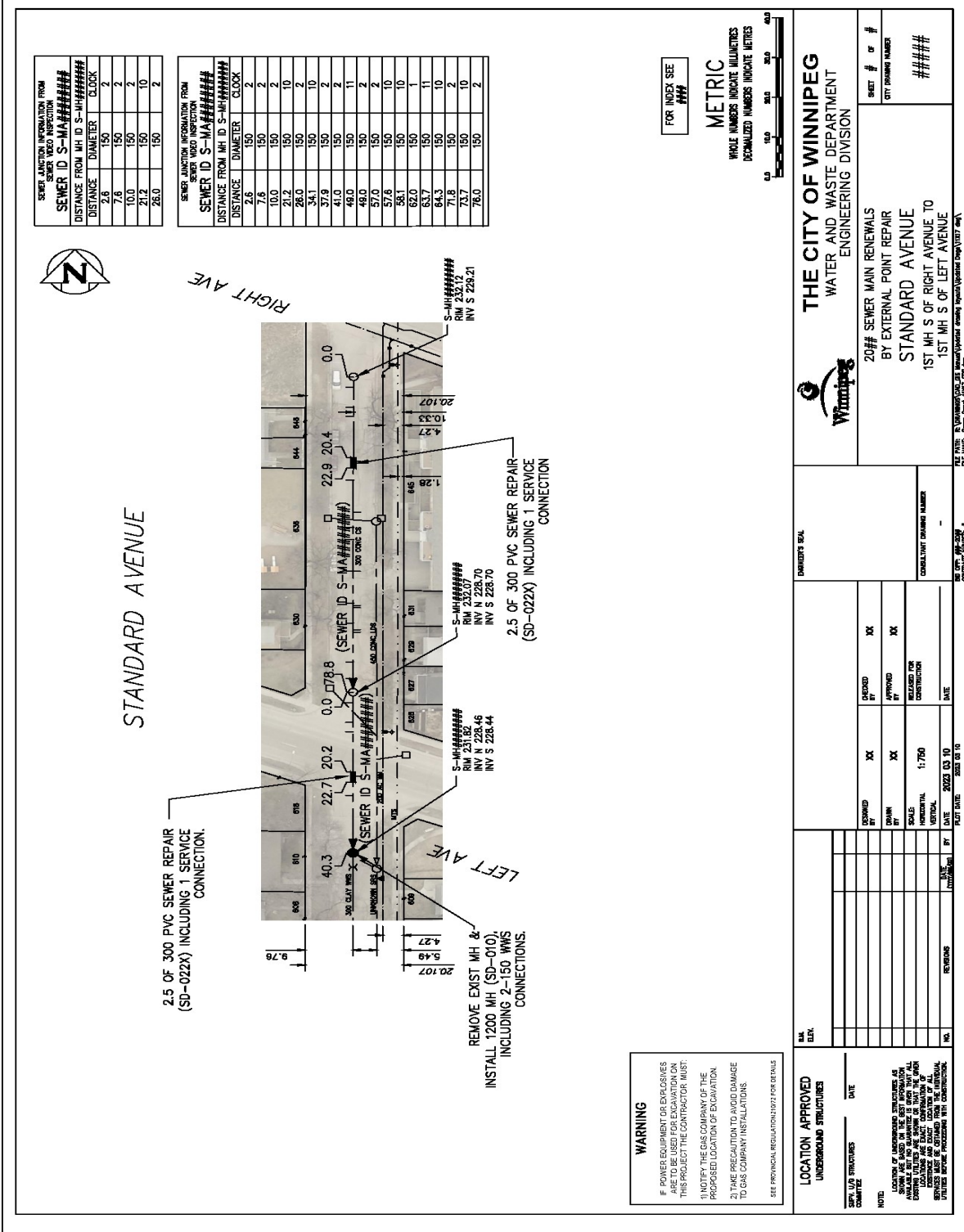

WARNING
 IF POWER EQUIPMENT OR EXPLOSIVES ARE TO BE USED FOR EXCAVATION ON THIS PROJECT THE CONTRACTOR MUST:
 1) NOTIFY THE GAS COMPANY OF THE PROPOSED LOCATION OF EXCAVATION
 2) TAKE PRECAUTION TO AVOID DAMAGE TO GAS COMPANY INSTALLATIONS
 SEE PROVINCIAL REGULATION 1972 FOR DETAILS

FOR INDEX SEE
###

METRIC
 WHOLE NUMBERS INDICATE MILLIMETERS
 DECIMALIZED NUMBERS INDICATE METRES

THE CITY OF WINNIPEG
 WATER AND WASTE DEPARTMENT
 ENGINEERING DIVISION

20# SEWER MAIN RENEWALS
 BY EXTERNAL POINT REPAIR
 STANDARD AVENUE
 1ST. MH S OF RIGHT AVENUE TO
 1ST. MH S OF LEFT AVENUE

SHEET # OF #
 CITY PROJECT NUMBER
 #####

DATE: 2022-03-10
 SCALE: 1:750
 CONTRACT NUMBER: 11087-2022

LOCATION APPROVED UNDERGROUND STRUCTURES

DATE	BY	REVISIONS

DATE	BY	REVISIONS

DATE	BY	REVISIONS

NOTE:
 LOCATION OF UNDERGROUND STRUCTURES AS SHOWN ON THIS DRAWING IS BASED ON AVAILABLE DATA AND IS NOT A GUARANTEE THAT ALL UTILITIES HAVE BEEN LOCATED. CONTRACTOR'S RESPONSIBILITY IS TO VERIFY THE LOCATION OF ALL UTILITIES BEFORE PROCEEDING WITH CONSTRUCTION.

APPENDIX K - AUGMENTATED CONSTRUCTION DRAWING (11X17)

11" x 17" Augmented Lining Construction Drawing

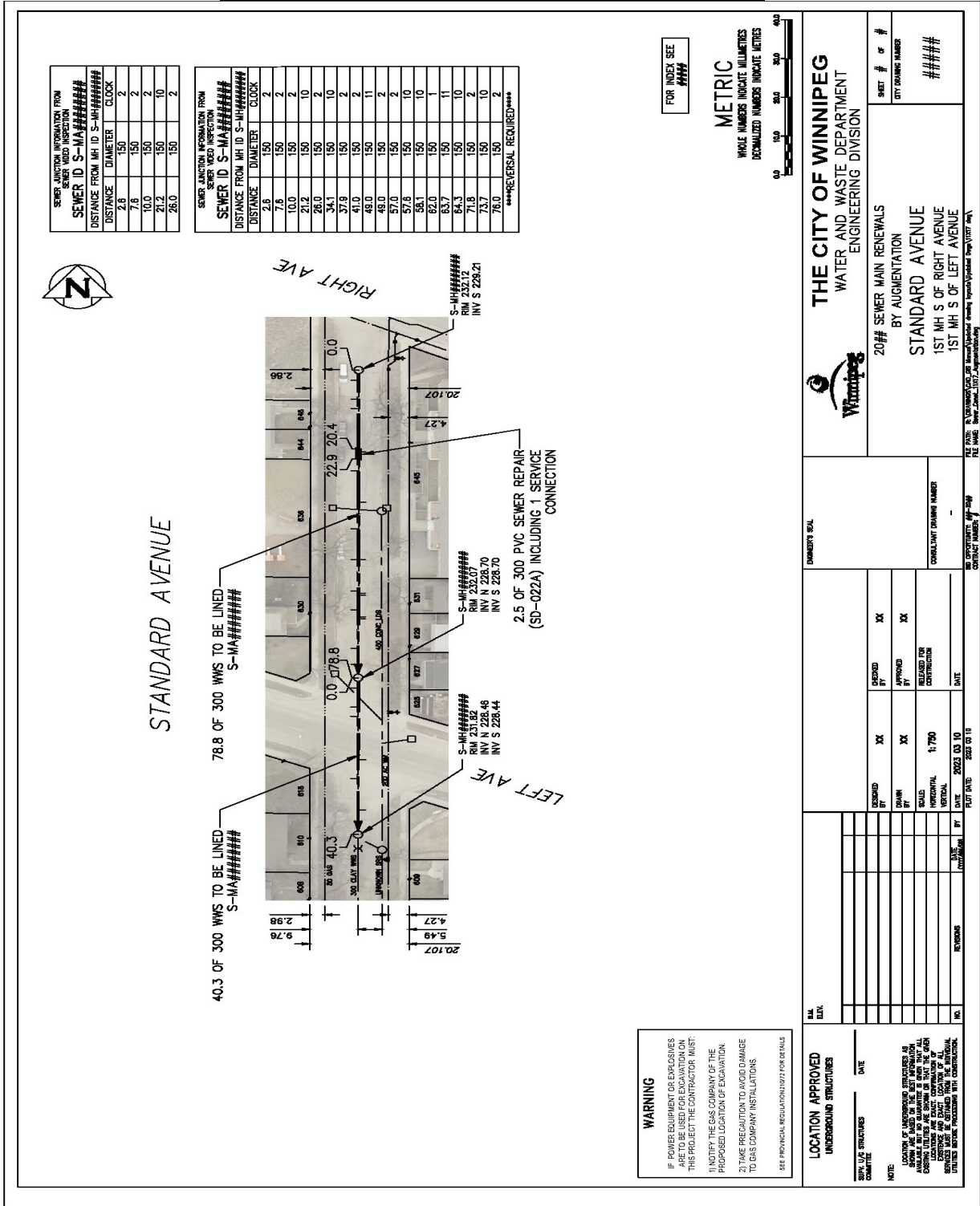

APPENDIX L- DETAIL BASE DRAWING (A1)

Oversize ISO A1 (594 mm x 841 mm) Detail Sheet (Construction Dwg)

FOR INDEX SEE
-

<p>LOCATION APPROVED UNDESIGNED DISTRICTS</p> <p>DATE: _____</p> <p>BY: _____</p> <p>NOTE: THE CITY OF WINNIPEG ENGINEERING SERVICES AS A PROFESSIONAL ENGINEERING FIRM IS PROVIDING THESE SERVICES AS AN ENGINEER TO THE CITY OF WINNIPEG. THE CITY OF WINNIPEG ENGINEERING SERVICES IS NOT PROVIDING THESE SERVICES AS A PROFESSIONAL ENGINEERING FIRM TO ANY OTHER ENTITY.</p>	<p>OPTIONAL DATA (SEE PART 1 DRAWING)</p> <p>UNDESIGNED DISTRICTS: _____</p> <p>DATE: _____</p>	<p>FORMER'S NO.</p> <p>ORIGINAL SIGNED BY S.A. 000000 17/AM/JD</p> <p>CONSULTANT DRAWING NUMBER -</p>	<p>DATE 17/AM/JD</p>	<p>DATE 17/AM/JD</p>	<p>DATE 17/AM/JD</p>
<p>DATE: 02/22/10</p> <p>BY: S.A.</p> <p>DATE: 02/22/10</p> <p>BY: S.A.</p>					

FOR INDEX SEE
-

<p>THE CITY OF WINNIPEG WATER AND WASTE DEPARTMENT ENGINEERING SERVICES DIVISION 20## XXXXXXX XXXXXXX</p>	<p>DETAIL SHEET</p> <p>SHEET # OF # CITY DRAWING NUMBER: -</p>
--	---

1/2" = 1' SCALE PLAN
 1/4" = 1' SCALE SECTION
 20## XXXXXXX XXXXXXX

APPENDIX M - DETAIL BASE DRAWING (11X17)

11"x 17" Detail Sheet

<p>LOCATION APPROVED UNDERGROUND STRUCTURES</p> <p>SEPA, VIA STRUCTURES COMMITTEE DATE</p> <p>NOTE: LOCATIONS OF UNDERGROUND STRUCTURES AS SHOWN ARE BASED ON THE BEST INFORMATION AVAILABLE AND ARE NOT GUARANTEED. LOCATIONS ARE EXACT TO THE BEST OF OUR KNOWLEDGE AND SHOULD BE VERIFIED BY THE USER BEFORE PROCEEDING WITH CONSTRUCTION.</p>	<p>DATE: 2023 03 10</p> <p>SCALE: 1:750</p> <p>HORIZONTAL</p> <p>VERTICAL</p>	<p>DESIGNED BY: XX</p> <p>DRAWN BY: XX</p> <p>CHECKED BY: XX</p> <p>APPROVED BY: XX</p> <p>RELEASER FOR CONSTRUCTION: XX</p>	<p>DRIVER'S SEAL</p> <p>CONSULTANT DRAWING NUMBER</p>	<p style="text-align: center;">THE CITY OF WINNIPEG WATER AND WASTE DEPARTMENT ENGINEERING DIVISION</p> <p style="text-align: center;">20## XXXXX XXXXXXXX</p> <p style="text-align: center;">DETAIL SHEET</p> <p style="text-align: right;">SHEET # of # CITY DRAWING NUMBER #####</p>
<p>AM. ELEV.</p>		<p>DATE: 2023 03 10</p>		<p>FILE NAME: Path\Draw_1117.dwg</p>

APPENDIX N - TITLE BLOCK

Title Block

THE CITY OF WINNIPEG
WATER AND WASTE DEPARTMENT
ENGINEERING DIVISION

2014 LAND DRAINAGE
CONTRACT #
(STREET NAME)
XXXXXX ROAD TO
XXXXXXXXX ROAD

PROJECT NUMBER: XXXXXXXX
CONTRACT NUMBER: XXXXXXXX
DATE: 2014.12.15

WARRANTY PERIOD: 12 MONTHS

NO.	REVISION	DATE	BY
1			
2			
3			
4			
5			
6			
7			
8			
9			
10			
11			
12			
13			
14			
15			

LOCATION APPROVED
UNDERGROUND DIMENSIONS

DATE: 2014.12.15

BY: [Signature]

WARNING
IF POWER EQUIPMENT OR BFT JOBS
ARE TO BE BEEP FOR EXCAVATION OR
THIS PROJECT THE CONTRACTOR MUST
NOTIFY THE GAS COMPANY OF THE
PROPOSED LOCATION OF EXCAVATION
STAKE PRECAGON TO AVOID DAMAGE
TO GAS COMPANY INSTALLATIONS
BT FROM GAS EXCAVATION 11 FT FOR DETAILS

1

2

3

4

5

6

7

8

9

10

11

12

13

14

15

APPENDIX O - LEGEND (PART 1)

Legend Part 1

LEGEND

DESCRIPTION	PLAN VIEW		
	ABANDONED	EXISTING	PROPOSED
WATER PIPE	---	---	---
FIRE HYDRANT	⊙	⊕	⊕
VALVE	⊙	⊙	⊙
CURB STOP	⊙	⊙	⊙
REDUCER	△	△	△
COUPLING OR SLIDDER	⊗	⊗	⊗
CROSS	⊕	⊕	⊕
BEND - 11.25°, 22.5°, 45°, 90°	⌒	⌒	⌒
TEE	⌒	⌒	⌒
VERTICAL BEND	⌒	⌒	⌒
ANODE	⌒	⌒	⌒
REPAIR MARKER	⌒	⌒	⌒
PLUG	⌒	⌒	⌒
SEWER PIPE	---	---	---
MANHOLE	○	○	●
CATCH BASIN	□	□	■
CURB INLET	▽	▽	▽
JUNCTION	⌒	⌒	⌒
DITCH	⌒	⌒	⌒
CULVERT	⌒	⌒	⌒
SURVEY BAR	⌒	⌒	⌒
SURVEY MONUMENT	⌒	⌒	⌒
TREE - DECIDUOUS	⌒	⌒	⌒
TREE - CONIFEROUS	⌒	⌒	⌒
HYDRO	---	---	---
HYDRO POLE	---	---	---
LAMP STANDARD	---	---	---
HYDRO POLE W/STREET LIGHTING	---	---	---
POLE	---	---	---
GUY ANCHOR	---	---	---
M.T.S. POLE	---	---	---
PEDESTAL OR BOX	---	---	---
CABINET	---	---	---
M.T.S., SHAW, OR MDEON	---	---	---
TRAFFIC SIGNALS	---	---	---
TRAFFIC LIGHT STANDARD	---	---	---
GAS	---	---	---
STEAM	---	---	---
FIBRE OPTIC	---	---	---
FENCE	---	---	---
EDGE OF PAVEMENT OR GUTTER	---	---	---
EDGE UNPAVED OR GRAVEL ROAD	---	---	---
PROJECTED	---	---	---
LOT LINE	---	---	---
SIDEWALK - PATHWAY	---	---	---
EASEMENT	---	---	---
EDGE OF BUILDING	---	---	---
MAILBOX	---	---	---
PARKING METER	---	---	---
TEST HOLE	---	---	---
TREE LINE OR BUSH	---	---	---

















APPENDIX O (CONT.) - LEGEND (PART 2)

Legend Part 2

DESCRIPTION	ABANDONED	PROFILE	
		EXISTING	
WATER PIPE	-----	-----	=====
HYDRANT TOP		+	
VALVE	----- X -----	----- X -----	=====
TEE OR CROSS	----- O -----	----- O -----	=====
COUPLING OR BEND	----- I -----	----- I -----	=====
REDUCER	-----] <div style="display: inline-block; width: 10px; height: 10px; border: 1px solid black; vertical-align: middle;"></div> -----	-----] <div style="display: inline-block; width: 10px; height: 10px; border: 1px solid black; vertical-align: middle;"></div> -----	=====
END OF PIPE		o	
SEWER PIPE	-----	-----	=====
UNPAVED GROUND SURFACE			
PAVED GROUND SURFACE - Q PIPE		----- x x x -----	
GUTTER (NORTH AND WEST)		----- □ □ -----	
GUTTER (SOUTH AND EAST)		----- ○ ○ -----	
Q DITCH (NORTH AND WEST)		----- △ △ -----	
Q DITCH (SOUTH AND EAST)		----- ▽ ▽ -----	



















APPENDIX P - SYMBOL LIST (PART 1)

Symbol List Part 1

STANDARD BLOCKS			
BLOCK SYMBOL	BLOCK NAME (.dwg)	LAYER NAME	DESCRIPTION
	E_11 Bend	E_WATER_PLAN or E_SEWER_PLAN	EXISTING 11.25° BENDS FOR SEWER OR WATER
	E_22 Bend	E_WATER_PLAN or E_SEWER_PLAN	EXISTING 22.5° BENDS FOR SEWER OR WATER
	E_45 Bend	E_WATER_PLAN or E_SEWER_PLAN	EXISTING 45° BENDS FOR SEWER OR WATER
	E_90 Bend	E_WATER_PLAN or E_SEWER_PLAN	EXISTING 90° BENDS FOR SEWER OR WATER
	E_Anode	E_WATER_PLAN	EXISTING ANODES
	E_Catch Basin	E_SEWER_PLAN	EXISTING CATCH BASIN
	E_Coupling	E_WATER_PLAN or E_SEWER_PLAN	EXISTING COUPLINGS FOR SEWER AND WATER
	E_Cross	E_WATER_PLAN or E_SEWER_PLAN	EXISTING CROSS FOR SEWER AND WATER
	E_Curb Inlet	E_SEWER_PLAN	EXISTING CURB INLET
	E_Curb Stop	E_WATER_PLAN	EXISTING CURB STOPS
	E_Hydrant	E_WATER_PLAN	EXISTING FIRE HYDRANT
	E_Manhole	E_SEWER_PLAN	EXISTING MANHOLES
	E_Plan_Flow_Arrow	E_SEWER_PLAN	EXISTING SEWER FLOW DIRECTION ARROW
	E_Plug	E_WATER_PLAN or E_SEWER_PLAN	EXISTING PLUG ON SEWER OR WATER
	E_Profile_Ellipse	E_WATER_PROFILE or E_SEWER_PROFILE	CROSSING SEWER OR WATER PIPE ON PROFILE
	E_Profile_Hydrant Top	E_WATER_PROFILE	SECTION OF HYDRANT ABOVE THE PROFILE
	E_Profile_Pipe End	E_WATER_PROFILE or E_SEWER_PROFILE	PIPE CONTINUATION AT LIMITS OF PROFILE

APPENDIX P (CON'T) – SYMBOL LIST (PART 2)

Symbol List Part 2

	E_Vertical Bend	E_WATER_PLAN or E_SEWER_PLAN	EXISTING VERTICAL BEND FOR SEWER
	Geodetic Bench Mark	LEGAL	GEODETTIC BENCH MARK LOCATION
	Guy Anchor	E_HYDRO_PLAN	UTILITY POLE SUPPORT ANCHOR
	Hydro Pole w_Street Light	E_HYDRO_PLAN	HYDRO POLE WITH STREET LIGHT ATT
	Hydro Pole	E_HYDRO_PLAN	HYDRO POLE
	Iron Bar	LEGAL	PROPERTY BARS
	Mail Box	0	MAIL BOX
	MTS Pole	E_MTS_PLAN	MTS POLE
	P_Profile_Ellipse	P_WATER_PROFILE or P_SEWER_PROFILE	PROPOSED SEWER OR WATER CROSS
	P_Profile_Flow Arrow	P_SEWER_PROFILE	PROPOSED SEWER FLOW DIRECTION
	P_Profile_Hydrant Top	P_WATER_PROFILE	SECTION OF HYDRANT ABOVE THE FL
	P_Profile_Pipe End	P_WATER_PROFILE or P_SEWER_PROFILE	PIPE CONTINUATION AT LIMITS OF PRO
	P_Profile_Valve	P_WATER_PROFILE or P_SEWER_PROFILE	PROPOSED VALVE IN PROFILE
	Pole	0	UNKNOWN POLE
	Repair Marker	P_WATER_PLAN or P_SEWER_PLAN	REPAIR LOCATION MARKERS FOR SEW
	Street Light	E_HYDRO_PLAN	LAMP STANDARD (STREET LIGHT)
	Test Hole	TEST_HOLES	TEST HOLE LOCATIONS
	Traffic Signal	E_SIGNALS_PLAN	TRAFFIC SIGNALS

APPENDIX P (CON'T) – SYMBOL LIST (PART 3)

Symbol List Part 3

STANDARD BLOCKS			
BLOCK SYMBOL	BLOCK NAME (.dwg)	LAYER NAME	DESC
/	A_11 Bend	E_WATER_ABAND_PLAN or E_SEWER_ABAND_PLAN	ABANDONED 11.25° BENDS FOR
/	A_22 Bend	E_WATER_ABAND_PLAN or E_SEWER_ABAND_PLAN	ABANDONED 22.5° BENDS FOR
/	A_45 Bend	E_WATER_ABAND_PLAN or E_SEWER_ABAND_PLAN	ABANDONED 45° BENDS FOR
└	A_90 Bend	E_WATER_ABAND_PLAN or E_SEWER_ABAND_PLAN	ABANDONED 90° BENDS FOR
◁	A_Reducer	E_WATER_ABAND_PLAN or E_SEWER_ABAND_PLAN	ABANDONED REDUCER FOR
□	A_Catch Basin	E_SEWER_ABAND_PLAN	ABANDONED CATCH BASIN
┌	E_Tee	E_WATER_ABAND_PLAN or E_SEWER_ABAND_PLAN	ABANDONED TEE FOR SEWER
┌	A_Cross	E_WATER_ABAND_PLAN or E_SEWER_ABAND_PLAN	ABANDONED CROSS FOR SEWER
▽	A_Curb Inlet	E_SEWER_ABAND_PLAN	ABANDONED CURB INLET
♂	A_Curb Stop	E_WATER_ABAND_PLAN	ABANDONED CURB STOPS
⊗	A_Valve	E_WATER_ABAND_PLAN or E_SEWER_ABAND_PLAN	ABANDONED VALVE FOR SEWER
○	A_Manhole	E_SEWER_ABAND_PLAN	ABANDONED MANHOLES
	A_Vertical Bend	E_WATER_ABAND_PLAN or E_SEWER_ABAND_PLAN	ABANDONED VERTICAL BEND
]	A_Plug	E_WATER_ABAND_PLAN or E_SEWER_ABAND_PLAN	ABANDONED PLUG ON SEWER
∩	A_Profile_Ellipse	E_WATER_ABAND_PLAN or E_SEWER_ABAND_PLAN	INTERSECTING SEWER OR WATER

APPENDIX Q – PLOT STYLES

Plot Styles

Plot Style Table Editor - STANDARD_CAD.ctb

General | Table View | Form View

	Color 1	Color 2	Color 3	Color 4	Color 5	Color 6	Color 7	Color 8	Color 9
Name	Color 1	Color 2	Color 3	Color 4	Color 5	Color 6	Color 7	Color 8	Color 9
Description	Description_1	Description_2	Description_3	Description_4	Description_5	Description_6	Description_7	Description_8	Description_9
Color	Black	Black	Black	Black	Black	Black	Black	Black	Black
Enable dithering	Off	Off	Off	Off	Off	Off	Off	On	On
Convert to grayscale	Off	Off	Off	Off	Off	Off	Off	On	On
Use assigned pen #	7	7	7	7	7	7	7	8	9
Virtual pen #	8	7	7	7	7	7	7	Automatic	Automatic
Screening	100	100	100	100	100	100	100	100	75
Linetype	Use object linetype	Use object linetype	Use object linetype	Use object linetype	Use object linetype	Use object linetype	Use object linetype	Use object linetype	Use object linetype
Adaptive adjustment	Off	Off	Off	Off	Off	Off	Off	Off	On
Lineweight	0.1800 mm	0.2500 mm	0.3000 mm	0.5000 mm	0.7000 mm	0.2000 mm	0.2500 mm	0.0060 mm	0.1100 mm
Line End Style	Use object end style	Use object end style	Use object end style	Use object end style	Use object end style	Use object end style	Use object end style	Use object end style	Use object end style
Line Join Style	Use object join style	Use object join style	Use object join style	Use object join style	Use object join style	Use object join style	Use object join style	Use object join style	Use object join style
Fill Style	Use object fill style	Use object fill style	Use object fill style	Use object fill style	Use object fill style	Use object fill style	Use object fill style	Use object fill style	Use object fill style

APPENDIX R - WATER RECORD DRAWING (A1)

Oversize ISO A1 (594 mm x 841 mm) Plan/Profile Record Drawing – Water

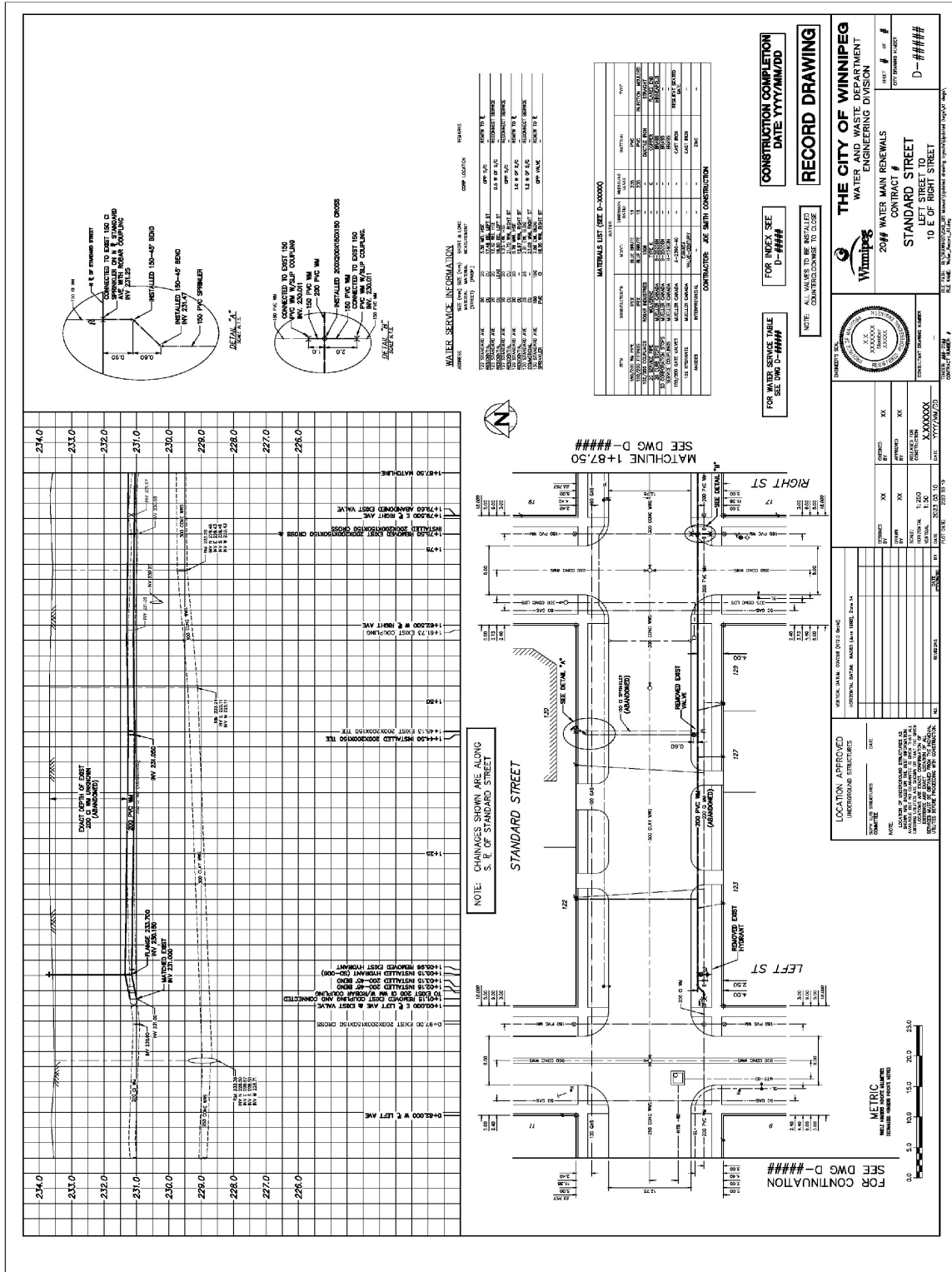

APPENDIX T – OPEN CHANNEL RECORD DRAWING (A1)

Oversize ISO A1 (594 mm x 841 mm) Plan/Profile Record Drawing – Open Channel (Ditching)

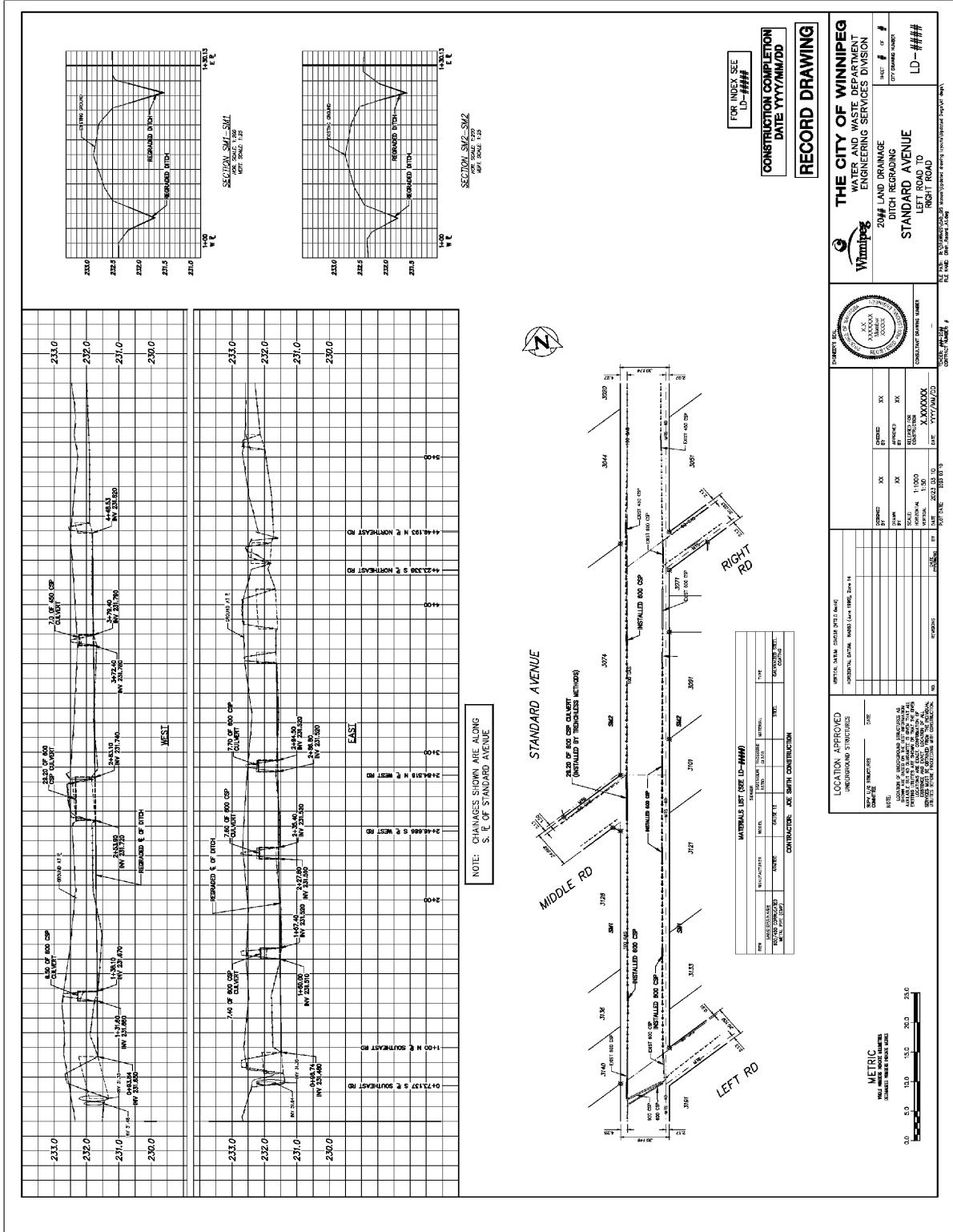

PPENDIX U – CIPP RECORD DRAWING (11X17)

11" x 17" Sewer Renewal by CIPP Lining Record Drawing

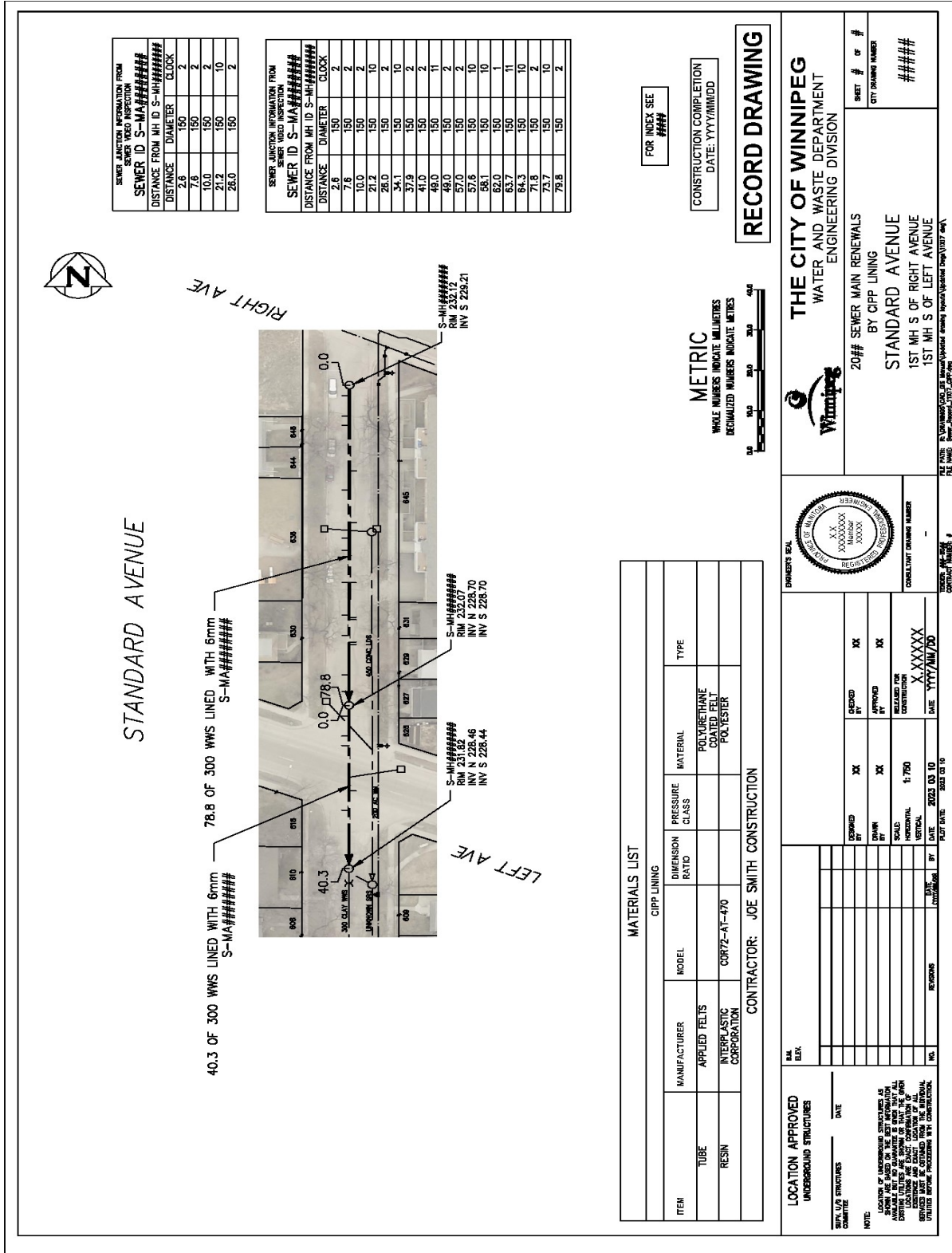

SEWER JUNCTION INFORMATION FROM SEWER VIDEO INSPECTION
SEWER ID S-WA#####

DISTANCE FROM MH ID S-WH#####	DIAMETER	CLOCK
2.6	150	2
7.6	150	2
10.0	150	2
21.2	150	10
26.0	150	2

SEWER JUNCTION INFORMATION FROM SEWER VIDEO INSPECTION
SEWER ID S-WH#####

DISTANCE FROM MH ID S-WH#####	DIAMETER	CLOCK
2.6	150	2
7.6	150	2
10.0	150	2
21.2	150	10
26.0	150	2
34.1	150	10
37.9	150	2
41.0	150	2
49.0	150	11
57.0	150	2
57.6	150	10
66.1	150	10
62.0	150	1
63.7	150	11
64.3	150	10
71.8	150	2
73.7	150	10
79.8	150	2

FOR INDEX SEE
###

CONSTRUCTION COMPLETION
DATE: YYYY/MM/DD

RECORD DRAWING

METRIC
WHOLE NUMBERS INDICATE MILLIMETRES
DECIMALIZED NUMBERS INDICATE METRES



THE CITY OF WINNIPEG
WATER AND WASTE DEPARTMENT
ENGINEERING DIVISION

20# SEWER MAIN RENEWALS BY CIPP LINING
STANDARD AVENUE
1ST MH S OF RIGHT AVENUE
1ST MH S OF LEFT AVENUE

CONTRACT NUMBER: 1107-237-23
SHEET # OF #
CITY DRAWING NUMBER
#####

OWNER'S SEAL
REGISTERED PROFESSIONAL ENGINEER
REGISTERED NUMBER: XXXXXXXX
REGISTERED PROVINCE: XXXXX
REGISTERED YEAR: XXXXX
CONSULTANT DRAWING NUMBER: X-XXXXX
DATE: YYYY/MM/DD

MATERIALS LIST

CIPP LINING

ITEM	MANUFACTURER	MODEL	DIMENSION RATIO	PRESSURE CLASS	MATERIAL	TYPE
TUBE	INTERESTIC CORPORATION	COR72-AI-470			POLYURETHANE COATED FELT	XX
RESIN	INTERESTIC CORPORATION				POLYESTER	XX

CONTRACTOR: JOE SMITH CONSTRUCTION

LOCATION APPROVED UNDERGROUND STRUCTURES

DATE: _____

NOTE: LOCATION OF UNDERGROUND STRUCTURES AS AVAILABLE, BUT NO GUARANTEE IS GIVEN THAT ALL LOCATIONS ARE EXACT. CONFIRMATION OF UTILITIES MUST BE OBTAINED FROM THE UTILITY UTILITIES BEFORE PROCEEDING WITH CONSTRUCTION.

NO. _____ DATE: _____ SHEET 03 OF 10

APPENDIX V- EPR/TPR RECORD DRAWING (11X17)

11" x 17" External Point Repair (EPR) and Trenchless Point Repair (TPR) Record Drawing

STANDARD AVENUE

LEFT AVE

RIGHT AVE

2.5 OF 300 PVC SEWER REPAIRED (SD-022X) INCLUDING 1 SERVICE CONNECTION, N:CONNECTED W/MISSION COUPLING, INV: ####, S:CONNECTED W/DONUT (BUSHING), INV: ####

REMOVED EXIST MH & INSTALLED 1200 MH (SD-010), INCLUDING 2-150 WWS CONNECTIONS, RIM ####, INV N ####, INV S ####

2.5 OF 300 PVC SEWER REPAIRED (SD-022X) INCLUDING 1 SERVICE CONNECTION, N:CONNECTED W/MISSION COUPLING, INV: ####, S:CONNECTED W/MISSION COUPLING, INV: ####

SEWER LATERAL INFORMATION FROM SEWER VIDEO INSPECTION		
SEWER ID	S-MA#####	
DISTANCE FROM MH ID	S-MA#####	CLOCK
7.6	150	2
7.6	150	2
10.0	150	2
21.2	150	10
26.0	150	2

SEWER LATERAL INFORMATION FROM SEWER VIDEO INSPECTION		
SEWER ID	S-MA#####	
DISTANCE FROM MH ID	S-MA#####	CLOCK
2.6	150	2
7.6	150	2
10.0	150	2
21.2	150	10
26.0	150	2
37.8	150	2
41.0	150	2
46.0	150	11
46.0	150	2
57.0	150	10
57.8	150	10
58.1	150	10
62.0	150	10
63.7	150	11
64.3	150	10
71.8	150	2
73.7	150	10
76.0	150	2

MATERIALS LIST		
EXTERNAL PIPE REPAIR		
BASE WATER SERIES		
200 SERVICE PIPE	ROYAL SEAL	PVC
150 SERVICE PIPE	ROYAL SEAL	PVC
100 SERVICE PIPE	ROYAL SEAL	PVC
150 BUSHING	MISSION COUPLING	MISSION COUPLING
150 DONUT	MISSION COUPLING	MISSION COUPLING
MARKER FRAMES AND COUPES	TF-10-B	CAST IRON
CONTRACTOR: #####		

RECORD DRAWING		
CONSTRUCTION COMPLETION DATE: YYYY/MM/DD		

FOR INDEX SEE #####

METRIC

WHOLE NUMBERS INDICATE MILLIMETERS
DECIMALIZED NUMBERS INDICATE METRES

RECORD DRAWING

DATE: YYYY/MM/DD

CONTRACT #

STANDARD AVENUE

1ST MH S OF RIGHT AVENUE

1ST MH S OF LEFT AVENUE

THE CITY OF WINNIPEG

WATER AND WASTE DEPARTMENT

ENGINEERING DIVISION

20# SEWER MAIN RENEWALS

CONTRACT #

STANDARD AVENUE

1ST MH S OF RIGHT AVENUE

1ST MH S OF LEFT AVENUE

CONSTRUCTION COMPLETION DATE: YYYY/MM/DD

CONTRACTOR: #####

DATE: YYYY/MM/DD

DATE: YYYY/MM/DD

10-26

APPENDIX W – AUGMENTED RECORD DRAWING (11X17)

11" x 17" Augmented Lining Record Drawing

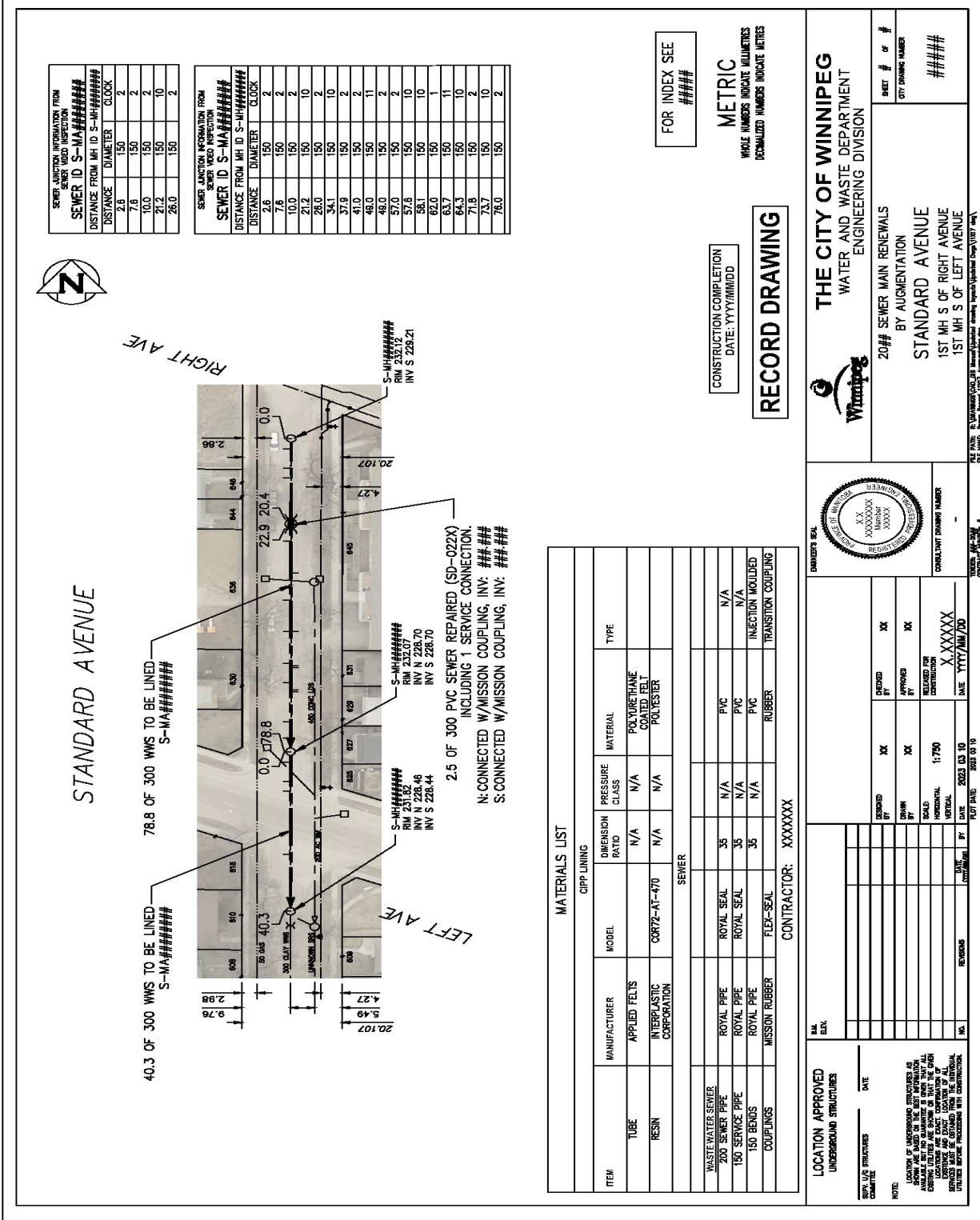

SEWER JUNCTION INFORMATION FROM SEWER VIDEO INSPECTION
SEWER ID S-MA#####

DISTANCE FROM MH ID S-W#	DIAMETER	CLOCK
2.6	150	2
7.6	150	2
10.0	150	2
21.2	150	2
26.0	150	2
34.1	150	10
37.9	150	2
41.0	150	2
48.0	150	11
48.0	150	2
57.0	150	2
57.8	150	10
58.1	150	10
62.0	150	1
63.7	150	11
64.3	150	10
71.8	150	2
73.7	150	10
76.0	150	2

SEWER JUNCTION INFORMATION FROM SEWER VIDEO INSPECTION
SEWER ID S-MA#####

DISTANCE FROM MH ID S-W#	DIAMETER	CLOCK
2.6	150	2
7.6	150	2
10.0	150	2
21.2	150	10
26.0	150	2
34.1	150	10
37.9	150	2
41.0	150	2
48.0	150	11
48.0	150	2
57.0	150	2
57.8	150	10
58.1	150	10
62.0	150	1
63.7	150	11
64.3	150	10
71.8	150	2
73.7	150	10
76.0	150	2

FOR INDEX SEE #####

METRIC
WHOLE NUMBERS INDICATE MILLIMETRES
DECIMAL NUMBERS INDICATE METRES

CONSTRUCTION COMPLETION
DATE: YYYYMMDD

RECORD DRAWING

THE CITY OF WINNIPEG
WATER AND WASTE DEPARTMENT
ENGINEERING DIVISION
20## SEWER MAIN RENEWALS
BY AUGMENTATION
STANDARD AVENUE
1ST MH S OF LEFT AVENUE
1ST MH S OF RIGHT AVENUE



MATERIALS LIST

ITEM	MANUFACTURER	MODEL	DIMENSION RATIO	PRESSURE CLASS	MATERIAL	TYPE
WASTE WATER SEWER						
200 SERVICE PIPE	ROYAL PIPE	ROYAL SEAL	35	N/A	PVC	N/A
150 SERVICE PIPE	ROYAL PIPE	ROYAL SEAL	35	N/A	PVC	N/A
150 BENDS	ROYAL PIPE	ROYAL SEAL	35	N/A	PVC	INJECTION MOLDED
COUPLINGS	MISSION RUBBER	FLEX-SEAL			RUBBER	TRANSITION COUPLING

CONTRACTOR: XXXXXXX

LOCATION APPROVED UNDERGROUND STRUCTURES

DATE: _____

NOTE: LOCATION OF UNDERGROUND STRUCTURES AS SHOWN ARE BASED ON THE BEST AVAILABLE INFORMATION. THE ENGINEER HAS CONDUCTED VISUAL INSPECTIONS OF THE EXISTING UTILITIES AND FOUND THAT THE UTILITIES EXISTENCE AND DEPTH LOCATIONS OF ALL UTILITIES WERE CONFIRMED WITH CONSTRUCTION.

DATE: 2023.03.10

DATE: 2023.03.10

APPENDIX X – GIS WATER DRAWING

Upsize ISO A1 (594 mm x 841 mm) GIS Drawing – Water

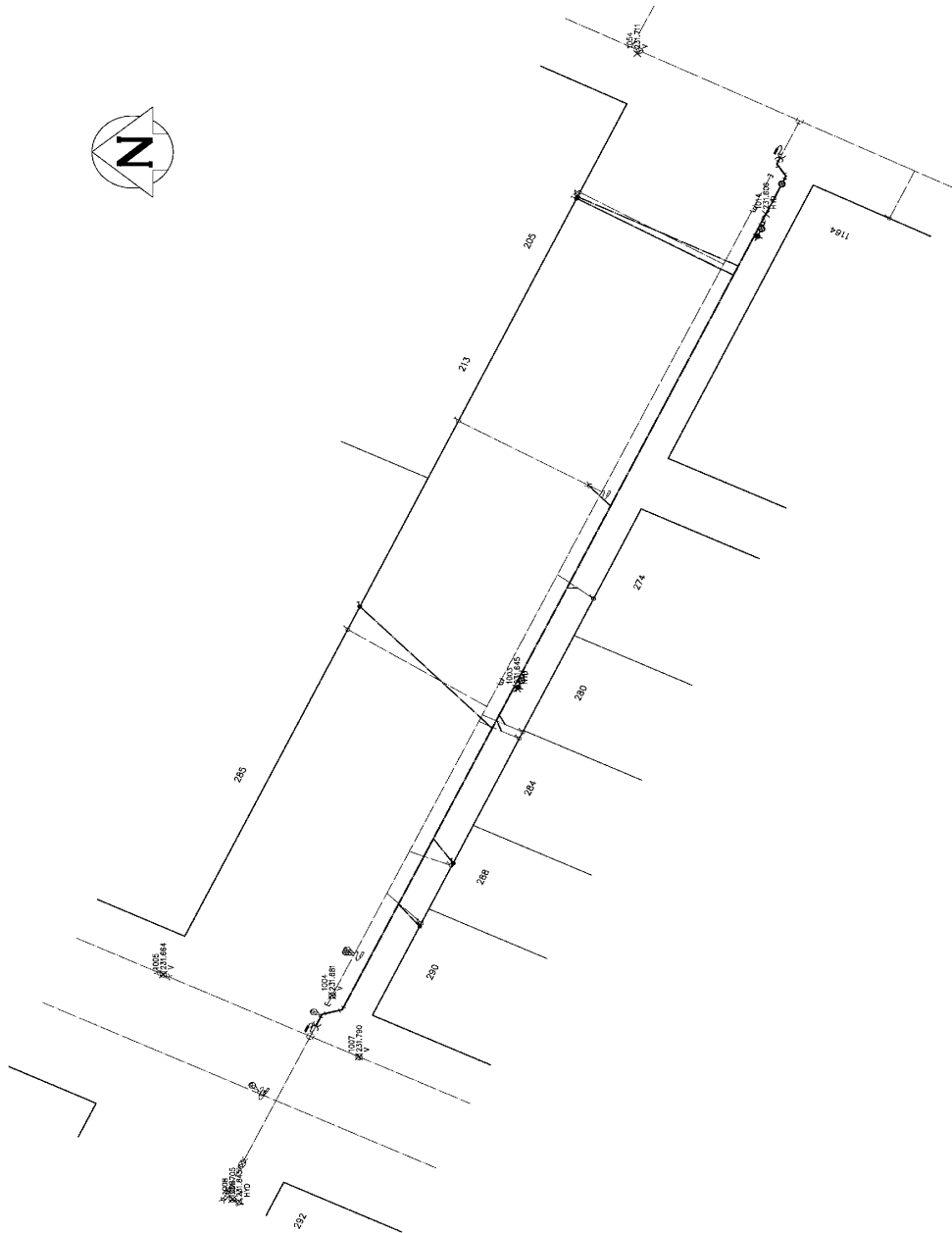

APPENDIX Y – GIS SEWER DRAWING

Upsize ISO A1 (594 mm x 841 mm) GIS Drawing – Sewer

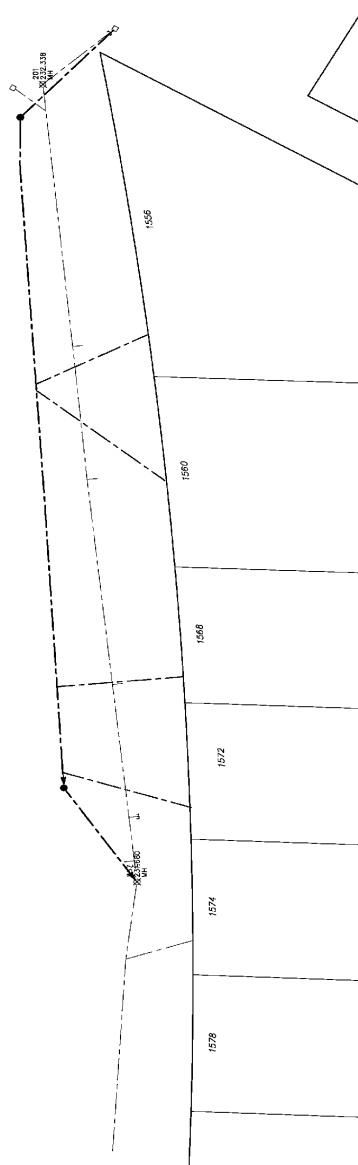

APPENDIX Z- GIS OPEN CHANNEL DRAWING

Upsize ISO A1 (594 mm x 841 mm) GIS Record Drawing – Open Channel (Ditching)

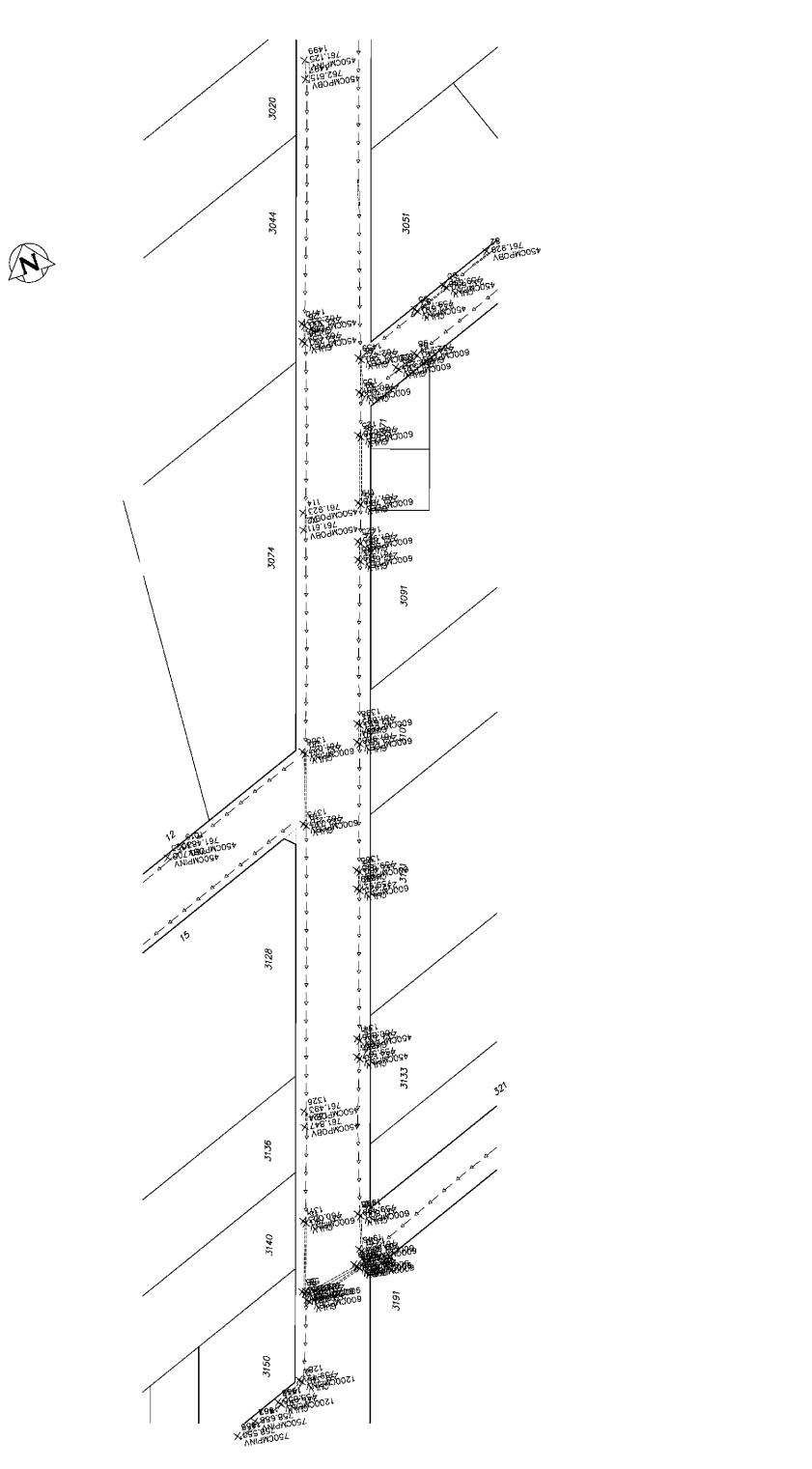

APPENDIX AA- GIS OPEN CHANNEL DRAWING

Oversize ISO A1 (594 mm x 841 mm) Along a Bend construction Drawing

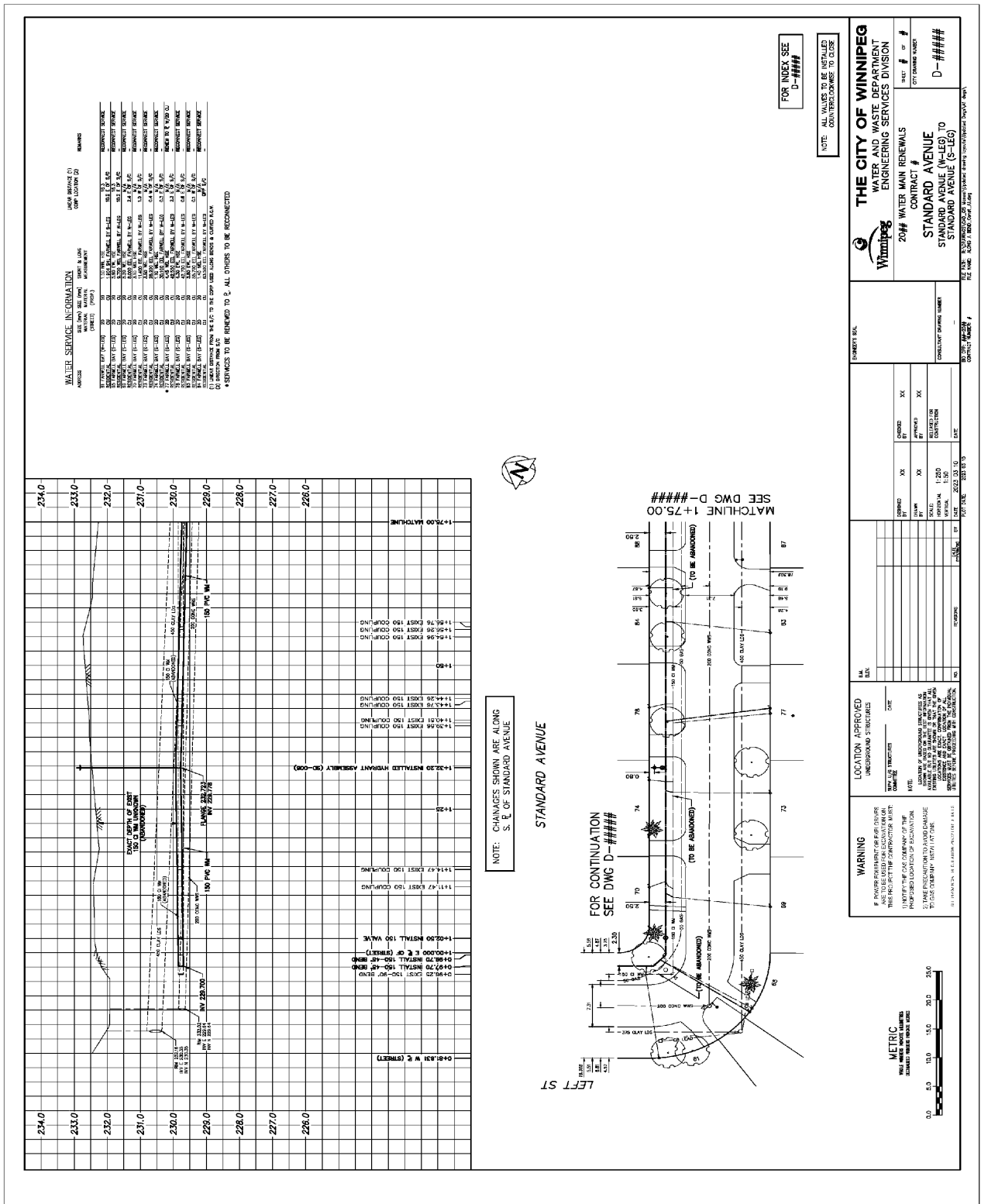

APPENDIX AB- GIS OPEN CHANNEL DRAWING

Oversize ISO A1 (594 mm x 841 mm) Along a Bend Record Drawing

